



jaga

CLIMATE DESIGNERS

AANSLUITSETS & VENTIELEN



INFO@JAGA.NL +31 (0)73 631 23 60

HEIMEIER WORDT GAMPPER

Leverbaar vanaf november 2023

Vanaf najaar 2023 wordt het Heimeier Eclipse ventiel vervangen door het nieuwe Gampper Vario-DP ventiel. Dit ventiel werkt drukonafhankelijk met een constant debiet dat instelbaar is tot 340 l/u.

De vormgeving van het Jaga Gampper Vario-DP ventiel is identiek aan het Jaga Heimeier Eclipse ventiel. Hierdoor is de compatibiliteit met de Jaga toestellen gegarandeerd.

150 l/u > **340 l/u**



OUD		NIEUW	
	CODE		CODE
G½	5090.5405	G½	5090.3405
Euroconus	5090.5407	Euroconus	5090.3407
SET	COLO	SET	COLO
262	COLO.EF2.	282	COLO.GF2.
265	COLO.EW2.	285	COLO.GW2.
161	COLO.HECW.	181	COLO.GACW.
162	COLO.HECF.	182	COLO.GACF.
163	COLO.HESW.	183	COLO.GASW.
164	COLO.HESF.	184	COLO.GASF.

**AL ONZE LOW-H₂O WARMTEWISSELAARS ZIJN
ZOWEL LINKS ALS RECHTS AANSLUITBAAR!**



AANSLUITING RECHTS

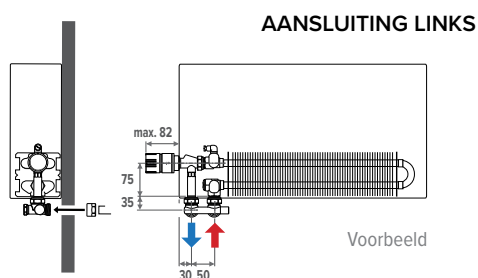
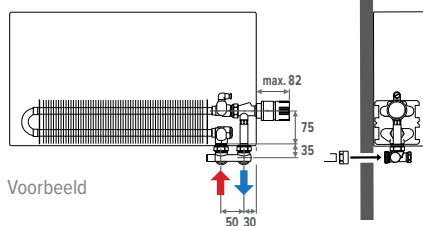

AANSLUITSETS & VENTIELEN

AANSLUITSETS

EUROCONUS

Naar de wand	6
Jaga H-blok	6
Jaga Crossflow Ventiel	8
Naar de vloer	10
Jaga H-blok	10
Jaga Crossflow H-blok	12
Naar de wand binnen de bekleding	14
Naar de vloer	15
Radiator	16
Mini Canal, Mini Canal Pro, Mini Canal Hybrid	16
Briza 12	17
Briza 22/26	18
Freedom	19
Clima Canal, Clima Beam	20

DN20 G3/4"

Radiator	22
Clima Beam	22
Briza 22/26	23

M24 X 1.5

Via onderzijde bekleding	24
Jaga Pro ventiel M24	24
Binnen de bekleding	26

M24 19/"

Jaga Deco Pro ventiel	28
Naar de wand	30
Naar de vloer	32
Eenpuntsventiel	33

LOSSE VENTIELEN

EUROCONUS

Jaga H-ventiel 3/4" Euroconus	36
-------------------------------	----

Jaga Crossflow Ventiel	37
Jaga ventiel 3/4" Euroconus	38
Jaga ventiel 3/4" recht	39
Jaga retourventielen 3/4" Euroconus	39
H-blok met puntstuk 3/4" Euroconus	40
Crossflow blok met puntstuk 3/4" Euroconus	40

BINNENDRAAD

Jaga ventiel 1/2" binnendraad	41
Jaga Gampper Vario DP ventiel 1/2" binnendraad	41
Verlengpijp	42
Jaga retourventielen 1/2" binnendraad	42
Verlengde ontlufter 1/8"	42
Adapter voor hybride installaties	43

DN20 G 3/4"

Jaga ventiel	44
--------------	----

M24 X 1.5

Jaga Pro ventiel M24	46
----------------------	----

M24 19/"

Jaga deco éénpuntsaansluiting	47
Jaga Deco Pro ventiel	48
Jaga Deco haaks ventiel	49
Jaga deco ventiel	50
Jaga deco retourventiel	51

KLEMKOPPELINGEN

Nikkel	52
Chroom	53

THERMOSTAATKOPPEN

DRUKVERLIEZEN

jaga

CLIMATE
DESIGNERS

AANSLUITSETS



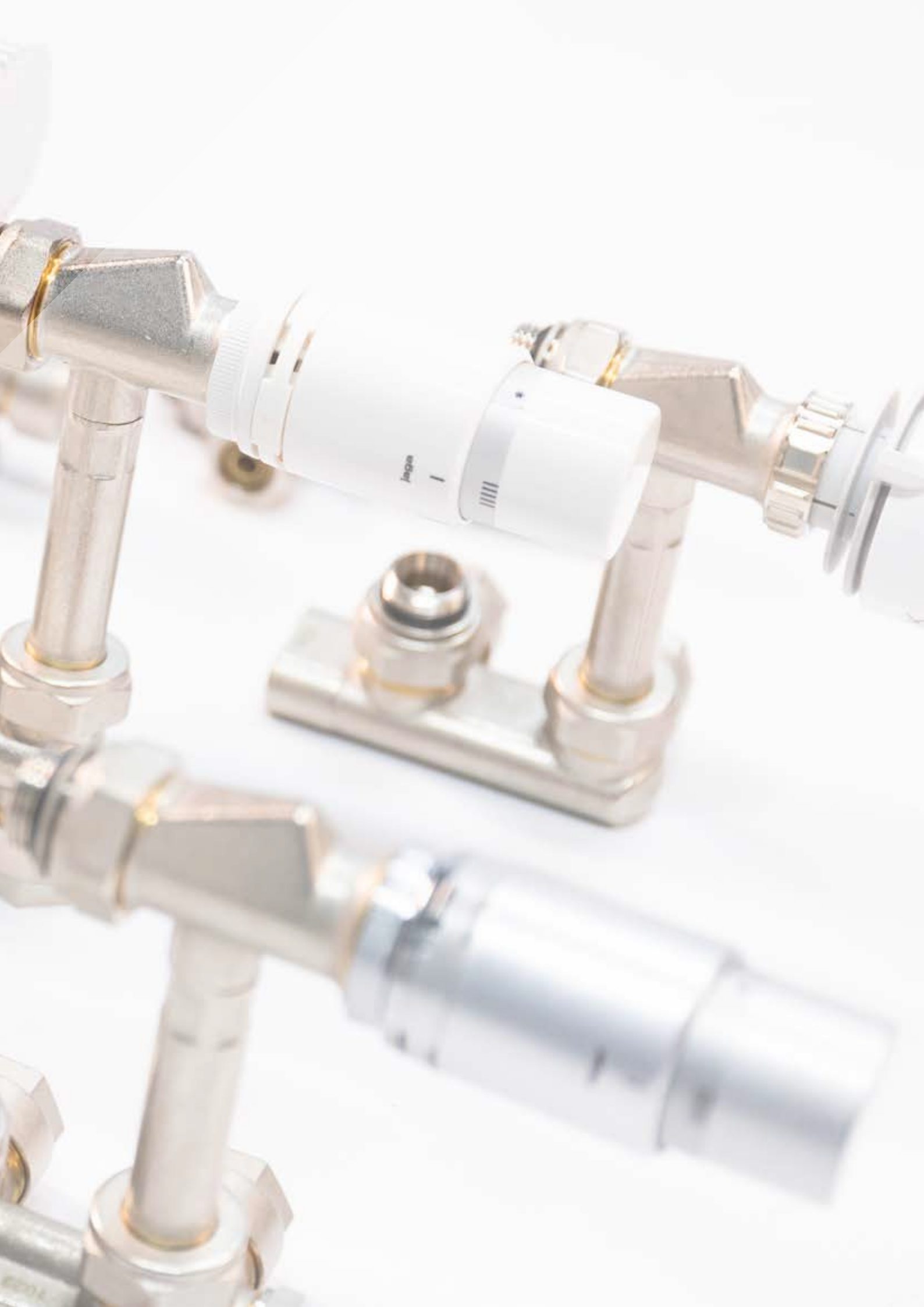

AANSLUITSETS EUROCONUS

NAAR DE WAND VIA ONDERZIJDE BEKLEDING MET JAGA H-BLOK

* Ook geschikt voor Light Cooling in combinatie met adapter 5090 1114.

SET 103

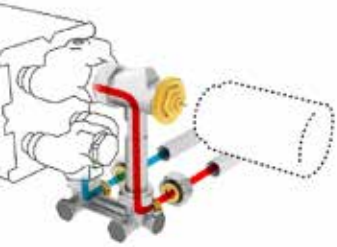

Naar de wand
Bediening beneden
Aanvoer buitenzijde
Kv 0.1 - 0.6 m³/u bij Δp = 1 bar
KVS 0.8
Tweepijp / Eenpijp

Thermostaatkop

Verwarmen *

Model	Code	Image
COLO HBSW JW 4 ..	JW	
COLO HBSW AC 4 ..	AC	
COLO HBSW AW 4 ..	AW	
COLO HBSW AS 4 ..	AS	
COLO HBSW AB 4 ..	AB	
COLO HBSW JH 4 ..	JH	

Verwarmen en koelen

COLO HBSW MA 4 ..	MA	
COLO HBSW HC 4 ..	HC	

Code klemkoppeling invullen

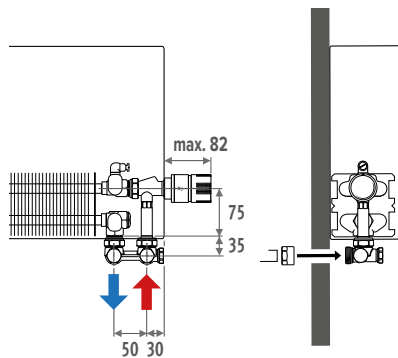

NIEUW

SET 183

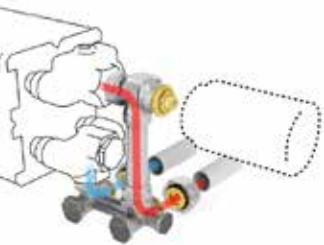

Naar de wand
Bediening beneden
Aanvoer buitenzijde
Automatische debietregeling (20 - 340 l/u)
Tweepijp / Eenpijp

Thermostaatkop

Verwarmen *

Model	Code	Image
COLO GASW JW 4 ..	JW	
COLO GASW AC 4 ..	AC	
COLO GASW AW 4 ..	AW	
COLO GASW AS 4 ..	AS	
COLO GASW AB 4 ..	AB	
COLO GASW JH 4 ..	JH	

Verwarmen en koelen

COLO GASW MA 4 ..	MA	
COLO GASW HC 4 ..	HC	

Code klemkoppeling invullen

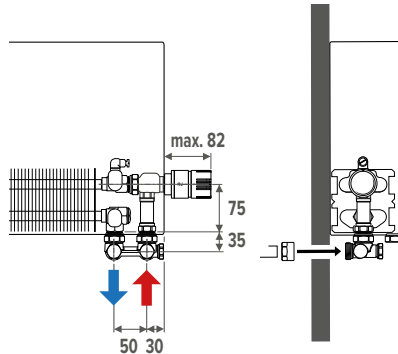

	STRADA TYPE 06	STRADA TYPE 10 < 21	LINEA PLUS	TEMPO	MINI WAND H 008	MINI WAND H 013 < 028	KNOCKONWOOD TYPE 06	KNOCKONWOOD TYPE 10 < 21	WANDINBOUW	MINI VRIJSTAAND	LINEA PLUS VRIJSTAAND	TEMPO VRIJSTAAND	STRADA HYBRID	WANDINBOUW HYBRID
Verwarmen *	-	✓	✓	✓	-	✓	-	✓	✓	-	-	-	✓	✓
Verwarmen en koelen	-	✓	✓	✓	-	✓	-	✓	✓	-	-	-	✓	✓

KLEMKOPPELINGEN EUROCONUS

BESTELVOORBEELD

Bestelcode aansluitset aanvullen met code klemkoppelingen volgens gebruikte buis en Ø. Inbegrepen in de prijs van de aansluitsets.

code aansluitset code klemkoppeling
COLO HBSW JW 4 112

Dunwandig metaal

CODE	BUIS Ø
112	12/1
114	14/1
115	15/1
116	16/1
118	18/1

Kunststof of VPE/ALU

CODE	BUIS Ø	CODE	BUIS Ø
612	12/2	615	15/2.5
614	14/2	619	16/1.5
616	16/2	620	20/2
618	18/2		

AANSLUITSETS EUROCONUS

NAAR DE WAND VIA ONDERZIJDE BEKLEDING MET JAGA H-BLOK

* Ook geschikt voor Light Cooling in combinatie met adapter 5090 1114.

SET 117

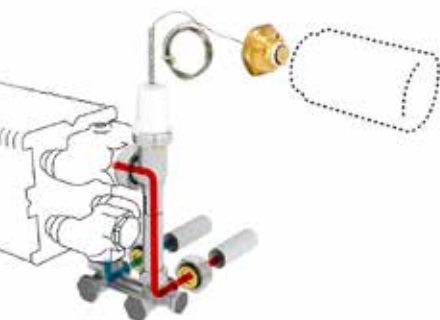

Naar de wand
Bediening boven
Aanvoer buitenzijde
Kv 0.1 - 0.6 m³/u bij Δp = 1 bar
KVS 0.8
Tweepijp / Eenpijp

De juiste positie van de bediening in de code opgeven.
30 (links) of 60 (rechts)
Vb.: STRW 050 100 16 60

Thermostaatkop

Verwarmen *

COLO VBSW JW 4 ..	JW	
COLO VBSW AC 4 ..	AC	
COLO VBSW AW 4 ..	AW	
COLO VBSW AS 4 ..	AS	
COLO VBSW AB 4 ..	AB	
COLO VBSW JH 4 ..	JH	

Verwarmen en koelen

COLO VBSW MA 4 ..	MA	
COLO VBSW HC 4 ..	HC	

Code klemkoppeling invullen

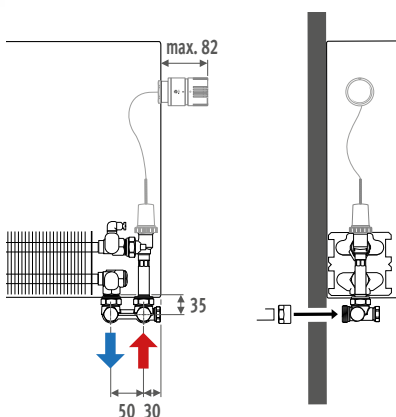

SET 113

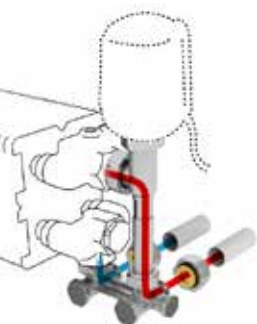

Naar de wand
Vanop afstand bediend
Aanvoer buitenzijde
Kv 0.1 - 0.6 m³/u bij Δp = 1 bar
KVS 0.8
Tweepijp / Eenpijp

De radiator heeft geen opening voor een thermostaatkop nodig; hiervoor dient u de aansluitcode te wijzigen naar /00.
Vb.: STRW 050 100 16 00

Thermostaatkop

Verwarmen *

COLO VBSW RD 4 ..	RD	
COLO VBSW RW 4 ..	RW	

Verwarmen en koelen

COLO VBSW 24 4 ..	24 (24 VDC)	
COLO VBSW 23 4 ..	23 (230 VAC)	

Code klemkoppeling invullen

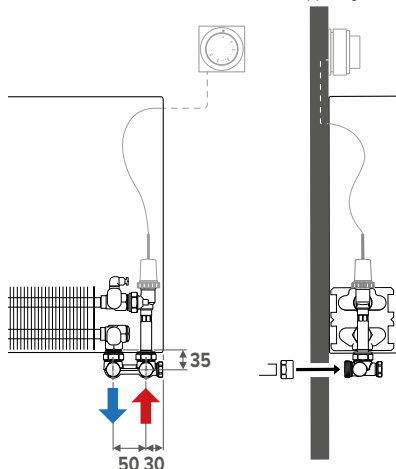

STRADA TYPE 06	STRADA TYPE 10 < 21	LINEA PLUS	TEMPO	MINI WAND H 008 -013	MINI WAND H 023 - 028	KNOCKONWOOD TYPE 06	KNOCKONWOOD TYPE 10 < 21	WANDINBOUW	MINI VRIJSTAAND	LINEA PLUS VRIJSTAAND	TEMPO VRIJSTAAND	STRADA HYBRID	WANDINBOUW HYBRID
----------------	---------------------	------------	-------	----------------------	-----------------------	---------------------	--------------------------	------------	-----------------	-----------------------	------------------	---------------	-------------------

-	✓	✓	✓	-	✓	-	✓	-	-	-	-	✓	✓
-	✓	✓	✓	-	✓	-	✓	-	-	-	-	✓	✓
-	✓	✓	✓	-	✓	-	✓	-	-	-	-	✓	✓
-	✓	✓	✓	-	✓	-	✓	-	-	-	-	✓	✓
-	✓	✓	✓	-	✓	-	✓	-	-	-	-	✓	✓
-	✓	✓	✓	-	✓	-	✓	-	-	-	-	✓	✓
-	✓	✓	✓	-	✓	-	✓	-	-	-	-	✓	✓
-	✓	✓	✓	-	✓	-	✓	-	-	-	-	✓	✓
-	✓	✓	✓	-	✓	-	✓	-	-	-	-	✓	✓

KLEMKOPPELINGEN EUROCONUS

BESTELVOORBEELD

Bestelcode aansluitset aanvullen met code klemkoppelingen volgens gebruikte buis en Ø.
Inbegrepen in de prijs van de aansluitsets.

code aansluitset code klemkoppeling
COLO VBSW JW 4 112

Dunwandig metaal

CODE	BUIS Ø
112	12/1
114	14/1
115	15/1
116	16/1
118	18/1

Kunststof of VPE/ALU

CODE	BUIS Ø	CODE	BUIS Ø
612	12/2	615	15/2.5
614	14/2	619	16/1.5
616	16/2	620	20/2
618	18/2		

AANSLUITSETS EUROCONUS

NAAR DE WAND VIA ONDERZIJDE BEKLEDING MET JAGA CROSSFLOW VENTIEL

** Ook geschikt voor Light Cooling in combinatie met adapter 5090 1114.*

SET 101

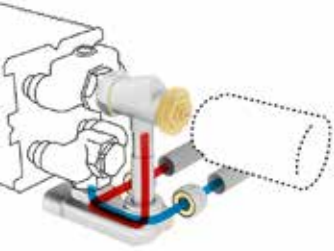

Naar de wand
Bediening beneden
Aanvoer binnenzijde
Kv 0.1 - 0.6 m³/u bij Δp = 1 bar
KVS 0.8
Tweepijp

Thermostaatkop

Verwarmen *

COLO HBCW JW 4 ..	JW	
COLO HBCW AC 4 ..	AC	
COLO HBCW AW 4 ..	AW	
COLO HBCW AS 4 ..	AS	
COLO HBCW AB 4 ..	AB	
COLO HBCW JH 4 ..	JH	

Verwarmen en koelen

COLO HBCW MA 4 ..	MA	
COLO HBCW HC 4 ..	HC	

Code klemkoppeling invullen

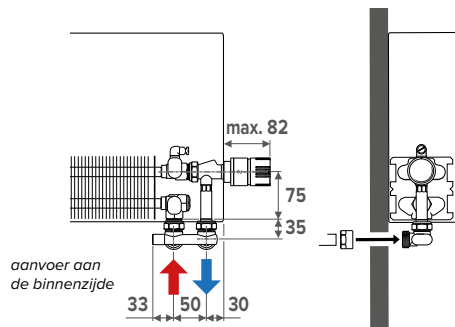

NIEUW

SET 181

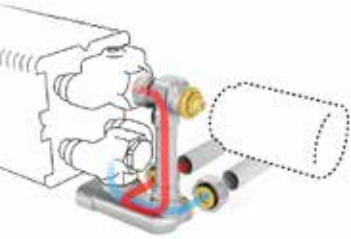

Naar de wand
Bediening beneden
Aanvoer binnenzijde
Automatische debietregeling (20 - 340 l/u)
Tweepijp

Thermostaatkop

Verwarmen *

COLO GACW JW 4 ..	JW	
COLO GACW AC 4 ..	AC	
COLO GACW AW 4 ..	AW	
COLO GACW AS 4 ..	AS	
COLO GACW AB 4 ..	AB	
COLO GACW JH 4 ..	JH	

Verwarmen en koelen

COLO GACW MA 4 ..	MA	
COLO GACW HC 4 ..	HC	

Code klemkoppeling invullen

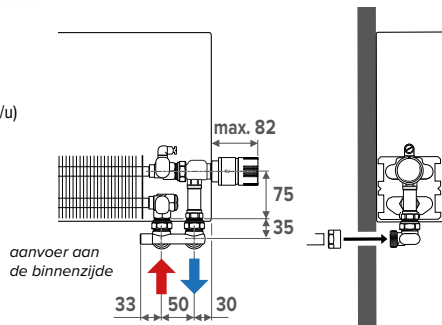

SET 101	STRADA TYPE 06	STRADA TYPE 10 < 21	LINEA PLUS	TEMPO	MINI WAND H 008	MINI WAND H 013 < 028	KNOCKONWOOD TYPE 06	KNOCKONWOOD TYPE 10 < 21	WANDINBOUW	MINI VRIJSTAAND	LINEA PLUS VRIJSTAAND	TEMPO VRIJSTAAND	STRADA HYBRID	WANDINBOUW HYBRID
	-	✓	✓	✓	-	✓	-	✓	✓	-	-	-	✓	✓
	-	✓	✓	✓	-	✓	-	✓	✓	-	-	-	✓	✓
	-	✓	✓	✓	-	✓	-	✓	✓	-	-	-	✓	✓
	-	✓	✓	✓	-	✓	-	✓	✓	-	-	-	✓	✓
	-	✓	✓	✓	-	✓	-	✓	✓	-	-	-	✓	✓
	-	✓	✓	✓	-	✓	-	✓	✓	-	-	-	✓	✓
	-	✓	✓	✓	-	✓	-	✓	✓	-	-	-	✓	✓
	-	✓	✓	✓	-	✓	-	✓	✓	-	-	-	✓	✓
	-	✓	✓	✓	-	✓	-	✓	✓	-	-	-	✓	✓
	-	✓	✓	✓	-	✓	-	✓	✓	-	-	-	✓	✓
	-	✓	✓	✓	-	✓	-	✓	✓	-	-	-	✓	✓

KLEMKOPPELINGEN EUROCONUS

Bestelvoorbeeld

Bestelcode aansluitset aanvullen met code klemkoppelingen volgens gebruikte buis en Ø. Inbegrepen in de prijs van de aansluitsets.

code aansluitset code klemkoppeling
COLO HBCW JW 4 112

Dunwandig metaal

CODE	BUIS Ø
112	12/1
114	14/1
115	15/1
116	16/1
118	18/1

Kunststof of VPE/ALU

CODE	BUIS Ø
612	12/2
614	14/2
616	16/2
618	18/2

CODE	BUIS Ø
615	15/2.5
619	16/1.5
620	20/2

AANSLUITSETS EUROCONUS

NAAR DE WAND VIA ONDERZIJDE BEKLEDING MET JAGA CROSSFLOW VENTIEL

* Ook geschikt voor Light Cooling in combinatie met adapter 5090 1114.

SET 115

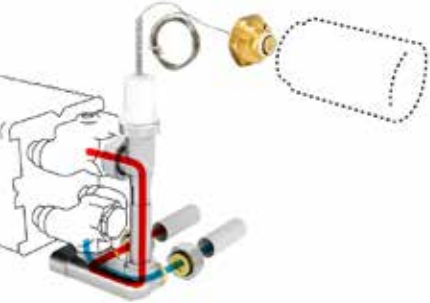

Naar de wand
Bediening boven
Aanvoer binnenzijde
Kv 0.1 - 0.6 m³/u bij Δp = 1 bar
KVS 0.8
Tweepijp

De juiste positie van de bediening in de code opgeven.
30 (links) of **60** (rechts)!
Vb.: STRW 050 100 16 **60**

Thermostaatkop

Verwarmen *

COLO VBCW JW 4 ..	JW	
COLO VBCW AC 4 ..	AC	
COLO VBCW AW 4 ..	AW	
COLO VBCW AS 4 ..	AS	
COLO VBCW AB 4 ..	AB	
COLO VBCW JH 4 ..	JH	

Verwarmen en koelen

COLO VBCW MA 4 ..	MA	
COLO VBCW HC 4 ..	HC	

Code klemkoppeling invullen

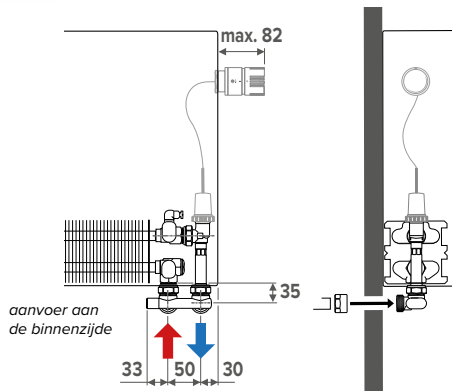

SET 111

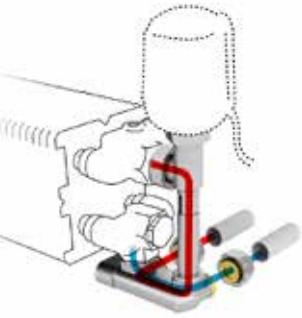

naar de wand
Vanop afstand bediend
Aanvoer binnenzijde
Kv 0.1 - 0.6 m³/u bij Δp = 1 bar
KVS 0.8
Tweepijp

De radiator heeft geen opening voor een thermostaatkop nodig; hiervoor dient u de aansluitcode te wijzigen naar /00.
Vb.: STRW 050 100 16 **00**

Thermostaatkop

Verwarmen *

COLO VBCW RD 4 ..	RD	
COLO VBCW RW 4 ..	RW	

Verwarmen en koelen

COLO VBCW 24 4 ..	24 (24 VDC)	
COLO VBCW 23 4 ..	23 (230 VAC)	

Code klemkoppeling invullen

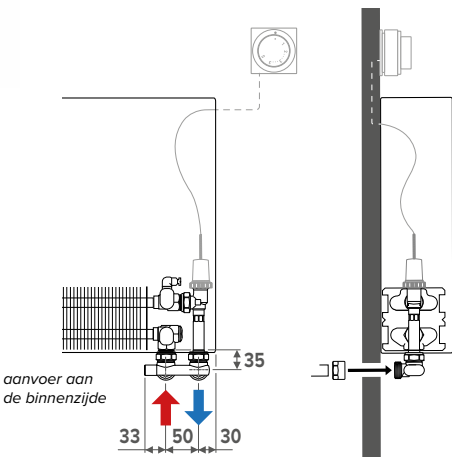

STRADA TYPE 06	STRADA TYPE 10 < 21	LINEA PLUS	TEMPO	MINI WAND H 008 -013	MINI WAND H 023 - 028	KNOCKONWOOD TYPE 06	KNOCKONWOOD TYPE 10 < 21	WANDINBOUW	MINI VRIJSTAAND	LINEA PLUS VRIJSTAAND	TEMPO VRIJSTAAND	STRADA HYBRID	WANDINBOUW HYBRID
-	✓	✓	✓	-	✓	-	✓	✓	-	-	-	✓	✓
-	✓	✓	✓	-	✓	-	✓	✓	-	-	-	✓	✓
-	✓	✓	✓	-	✓	-	✓	✓	-	-	-	✓	✓
-	✓	✓	✓	-	✓	-	✓	✓	-	-	-	✓	✓
-	✓	✓	✓	-	✓	-	✓	✓	-	-	-	✓	✓
-	✓	✓	✓	-	✓	-	✓	✓	-	-	-	✓	✓
-	✓	✓	✓	-	✓	-	✓	✓	-	-	-	✓	✓

KLEMKOPPELINGEN EUROCONUS

Bestelvoorbeeld

Bestelcode aansluitset aanvullen met code klemkoppelingen volgens gebruikte buis en Ø.
Inbegrepen in de prijs van de aansluitsets.

code aansluitset code klemkoppeling
COLO VBCW JW 4 **112**

Dunwandig metaal

CODE	BUIS Ø
112	12/1
114	14/1
115	15/1
116	16/1
118	18/1

Kunststof of VPE/ALU

CODE	BUIS Ø	CODE	BUIS Ø
612	12/2	615	15/2.5
614	14/2	619	16/1.5
616	16/2	620	20/2
618	18/2		

AANSLUITSETS EUROCONUS

NAAR DE VLOER MET JAGA H-VENTIEL

* Ook geschikt voor Light Cooling in combinatie met adapter 5090 1114.

SET 104

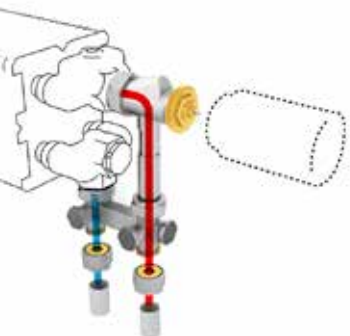

Naar de vloer
Bediening beneden
Aanvoer buitenzijde
Kv 0.1 - 0.6 m³/u bij Δp = 1 bar
KVS 0.8
Tweepijp / Eenpijp

Thermostaatkop

Verwarmen *

COLO HBSF JW 4 ..	JW	
COLO HBSF AC 4 ..	AC	
COLO HBSF AW 4 ..	AW	
COLO HBSF AS 4 ..	AS	
COLO HBSF AB 4 ..	AB	
COLO HBSF JH 4 ..	JH	

Verwarmen en koelen

COLO HBSF MA 4 ..	MA	
COLO HBSF HC 4 ..	HC	

Code klemkoppeling invullen

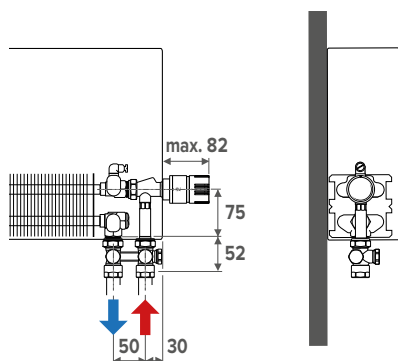

NIEUW

SET 184

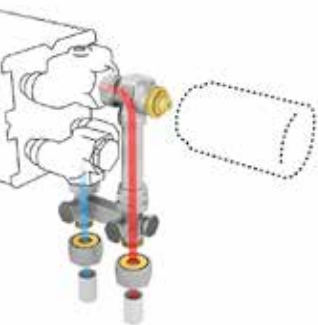

Naar de vloer
Bediening beneden
Aanvoer buitenzijde
Automatische debietregeling (20 - 340 l/u)
Tweepijp / Eenpijp

Thermostaatkop

Verwarmen *

COLO GASF JW 4 ..	JW	
COLO GASF AC 4 ..	AC	
COLO GASF AW 4 ..	AW	
COLO GASF AS 4 ..	AS	
COLO GASF AB 4 ..	AB	
COLO GASF JH 4 ..	JH	

Verwarmen en koelen

COLO GASF MA 4 ..	MA	
COLO GASF HC 4 ..	HC	

Code klemkoppeling invullen

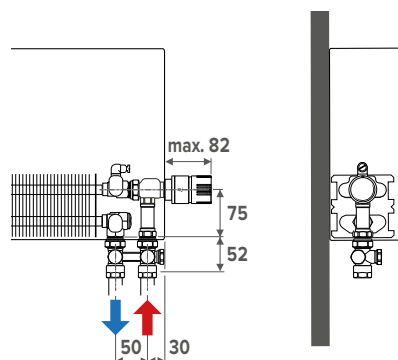

KLEMKOPPELINGEN EUROCONUS

Bestelvoorbeeld

Bestelcode aansluitset aanvullen met code klemkoppelingen volgens gebruikte buis en Ø.
Inbegrepen in de prijs van de aansluitsets.

code aansluitset code klemkoppeling
COLO HBSF JW 4 112

Dunwandig metaal

CODE	BUIS Ø
112	12/1
114	14/1
115	15/1
116	16/1
118	18/1

Kunststof of VPE/ALU

CODE	BUIS Ø	CODE	BUIS Ø
612	12/2	615	15/2.5
614	14/2	619	16/1.5
616	16/2	620	20/2
618	18/2		

	STRADA	LINEA PLUS	TEMPO	MINI WAND H 008	MINI WAND H 013 < 028	KNOCKONWOOD	WANDINBOUW	MINI VRIJSTAAND H 008	MINI VRIJSTAAND H 013 < 028	LINEA PLUS VRIJSTAAND	TEMPO VRIJSTAAND	STRADA HYBRID	WANDINBOUW HYBRID
Verwarmen *	✓	✓	✓	-	✓	✓	✓	-	✓	✓	✓	✓	✓
Verwarmen en koelen	✓	✓	✓	-	✓	✓	✓	-	✓	✓	✓	✓	✓

AANSLUITSETS EUROCONUS

NAAR DE VLOER MET JAGA H-VENTIEL

* Ook geschikt voor Light Cooling in combinatie met adapter 5090 1114.

SET 118

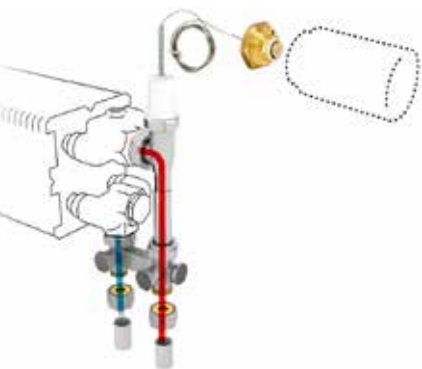

Naar de vloer
Bediening boven
Aanvoer buitenzijde
Kv 0.1 - 0.6 m³/u bij Δp = 1 bar
KVS 0.8
Tweepijp / Eenpijp

De juiste positie van de bediening in de code opgeven.
30 (links) of 60 (rechts)
Vb.: STRW 050 100 16 60

Thermostaatkop

Verwarmen *

COLO VBSF JW 4 ..	JW	
COLO VBSF AC 4 ..	AC	
COLO VBSF AW 4 ..	AW	
COLO VBSF AS 4 ..	AS	
COLO VBSF AB 4 ..	AB	
COLO VBSF JH 4 ..	JH	

Verwarmen en koelen

COLO VBSF MA 4 ..	MA	
COLO VBSF HC 4 ..	HC	

Code klemkoppeling invullen

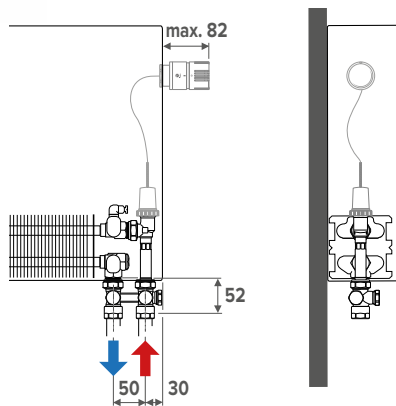

SET 114

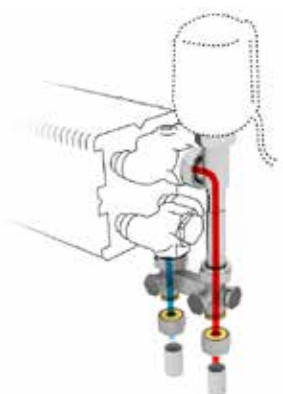

Naar de vloer
Vanop afstand bediend
Aanvoer buitenzijde
Kv 0.1 - 0.6 m³/u bij Δp = 1 bar
KVS 0.8
Tweepijp / Eenpijp

De radiator heeft geen opening voor een thermostaatkop nodig: hiervoor dient u de aansluitcode te wijzigen naar /00.
Vb.: STRW 050 100 16 00

Thermostaatkop

Verwarmen *

COLO VBSF RD 4 ..	RD	
COLO VBSF RW 4 ..	RW	

Verwarmen en koelen

COLO VBSF 24 4 ..	24 (24 VDC)	
COLO VBSF 23 4 ..	23 (230 VAC)	

Code klemkoppeling invullen

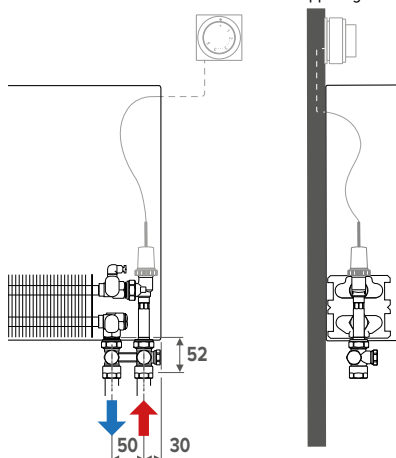

	STRADA	LINEA PLUS	TEMPO	MINI WAND H 008 -013	MINI WAND H 023 - 028	KNOCKONWOOD	WANDINBOUW	MINI VRIJSTAAND H 008	MINI VRIJSTAAND H 013 < 028	LINEA PLUS VRIJSTAAND	TEMPO VRIJSTAAND	STRADA HYBRID	WANDINBOUW HYBRID
✓	✓	✓	-	✓	✓	✓	✓	-	✓	✓	✓	✓	✓
✓	✓	✓	-	✓	✓	✓	✓	-	✓	✓	✓	✓	✓
✓	✓	✓	-	✓	✓	✓	✓	-	✓	✓	✓	✓	✓
✓	✓	✓	-	✓	✓	✓	✓	-	✓	✓	✓	✓	✓
✓	✓	✓	-	✓	✓	✓	✓	-	✓	✓	✓	✓	✓
✓	✓	✓	-	✓	✓	✓	✓	-	✓	✓	✓	✓	✓
✓	✓	✓	-	✓	✓	✓	✓	-	✓	✓	✓	✓	✓
✓	✓	✓	-	✓	✓	✓	✓	-	✓	✓	✓	✓	✓
✓	✓	✓	-	✓	✓	✓	✓	-	✓	✓	✓	✓	✓
-	-	-	-	-	-	-	-	-	-	-	-	✓	✓

KLEMKOPPELINGEN EUROCONUS

Bestelvoorbeeld

Bestelcode aansluitset aanvullen met code klemkoppelingen volgens gebruikte buis en Ø.
Inbegrepen in de prijs van de aansluitsets.

code aansluitset code klemkoppeling
COLO VBSF JW 4 112

Dunwandig metaal

CODE	BUIS Ø
112	12/1
114	14/1
115	15/1
116	16/1
118	18/1

Kunststof of VPE/ALU

CODE	BUIS Ø
612	12/2
614	14/2
616	16/2
618	18/2
615	15/2.5
619	16/1.5
620	20/2

AANSLUITSETS EUROCONUS

NAAR DE VLOER MET JAGA CROSSFLOW VENTIEL

* Ook geschikt voor Light Cooling in combinatie met adapter 5090 1114.



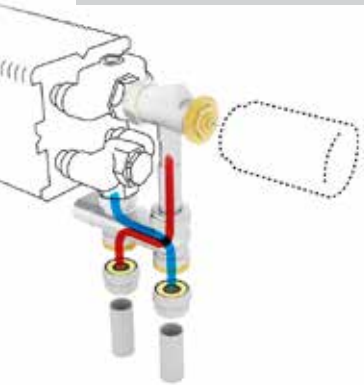



SET 102



Naar de vloer
Bediening beneden
Aanvoer binnenzijde
Kv 0.1 - 0.6 m³/u bij Δp = 1 bar
KVS 0.8
Tweepijp

Thermostaatkop

Verwarmen *

COLO HBCF JW 4 ..	JW	
COLO HBCF AC 4 ..	AC	
COLO HBCF AW 4 ..	AW	
COLO HBCF AS 4 ..	AS	
COLO HBCF AB 4 ..	AB	
COLO HBCF JH 4 ..	JH	

Verwarmen en koelen

COLO HBCF MA 4 ..	MA	
COLO HBCF HC 4 ..	HC	

Code klemkoppeling invullen

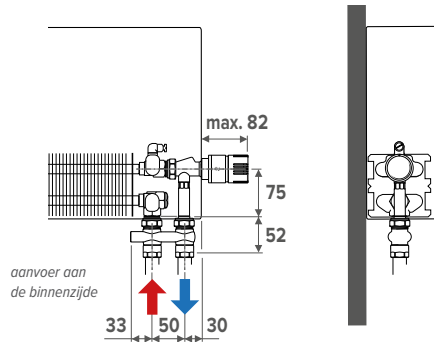

NIEUW



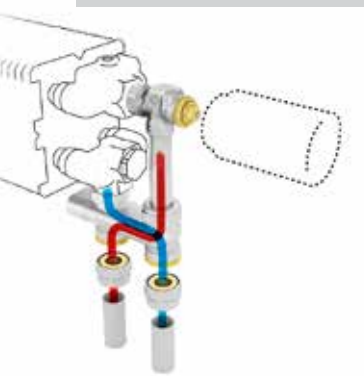



SET 182



Naar de vloer
Bediening beneden
Aanvoer binnenzijde
Automatische debietregeling (20 - 340 l/u)
Tweepijp

Thermostaatkop

Verwarmen *

COLO GACF JW 4 ..	JW	
COLO GACF AC 4 ..	AC	
COLO GACF AW 4 ..	AW	
COLO GACF AS 4 ..	AS	
COLO GACF AB 4 ..	AB	
COLO GACF JH 4 ..	JH	

Verwarmen en koelen

COLO GACF MA 4 ..	MA	
COLO GACF HC 4 ..	HC	

Code klemkoppeling invullen

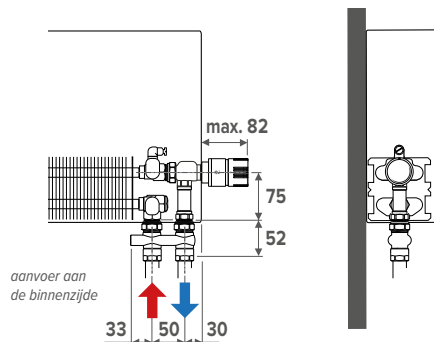

KLEMKOPPELINGEN EUROCONUS

Bestelvoorbeeld

Bestelcode aansluitset aanvullen met code klemkoppelingen volgens gebruikte buis en Ø.
Inbegrepen in de prijs van de aansluitsets.

code aansluitset code klemkoppeling
COLO HBCF JW 4 112

Dunwandig metaal

CODE	BUIS Ø
112	12/1
114	14/1
115	15/1
116	16/1
118	18/1

Kunststof of VPE/ALU

CODE	BUIS Ø	CODE	BUIS Ø
612	12/2	615	15/2.5
614	14/2	619	16/1.5
616	16/2	620	20/2
618	18/2		

	STRADA	LINEA PLUS	TEMPO	MINI WAND H 008	MINI WAND H 013 < 028	KNOCKONWOOD	WANDINBOUW	MINI VRIJSTAAND H 008	MINI VRIJSTAAND H 013 < 028	LINEA PLUS VRIJSTAAND	TEMPO VRIJSTAAND	STRADA HYBRID	WANDINBOUW HYBRID
Verwarmen *	✓	✓	✓	-	✓	✓	✓	-	✓	✓	✓	✓	✓
Verwarmen en koelen	✓	✓	✓	-	✓	✓	✓	-	✓	✓	✓	✓	✓
COLO HBCF JW 4 ..	✓	✓	✓	-	✓	✓	✓	-	✓	✓	✓	✓	✓
COLO HBCF AC 4 ..	✓	✓	✓	-	✓	✓	✓	-	✓	✓	✓	✓	✓
COLO HBCF AW 4 ..	✓	✓	✓	-	✓	✓	✓	-	✓	✓	✓	✓	✓
COLO HBCF AS 4 ..	✓	✓	✓	-	✓	✓	✓	-	✓	✓	✓	✓	✓
COLO HBCF AB 4 ..	✓	✓	✓	-	✓	✓	✓	-	✓	✓	✓	✓	✓
COLO HBCF JH 4 ..	✓	✓	✓	-	✓	✓	✓	-	✓	✓	✓	✓	✓
COLO HBCF MA 4 ..	✓	✓	✓	-	✓	✓	✓	-	✓	✓	✓	✓	✓
COLO HBCF HC 4 ..	-	-	-	-	-	-	-	-	-	-	-	✓	✓
COLO GACF JW 4 ..	✓	✓	✓	-	✓	✓	✓	-	✓	✓	✓	✓	✓
COLO GACF AC 4 ..	✓	✓	✓	-	✓	✓	✓	-	✓	✓	✓	✓	✓
COLO GACF AW 4 ..	✓	✓	✓	-	✓	✓	✓	-	✓	✓	✓	✓	✓
COLO GACF AS 4 ..	✓	✓	✓	-	✓	✓	✓	-	✓	✓	✓	✓	✓
COLO GACF AB 4 ..	✓	✓	✓	-	✓	✓	✓	-	✓	✓	✓	✓	✓
COLO GACF JH 4 ..	✓	✓	✓	-	✓	✓	✓	-	✓	✓	✓	✓	✓
COLO GACF MA 4 ..	✓	✓	✓	-	✓	✓	✓	-	✓	✓	✓	✓	✓
COLO GACF HC 4 ..	-	-	-	-	-	-	-	-	-	-	-	✓	✓

AANSLUITSETS EUROCONUS

NAAR DE VLOER MET JAGA CROSSFLOW VENTIEL

* Ook geschikt voor Light Cooling in combinatie met adapter 5090 1114.

SET 116

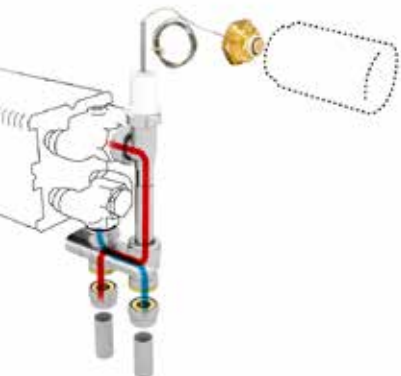

Naar de vloer
Bediening boven
Aanvoer binnenzijde
Kv 0.1 - 0.6 m³/u bij Δp = 1 bar
KVS 0.8
Tweepijp

De juiste positie van de bediening in de code opgeven.
30 (links) of **60** (rechts)
Vb.: STRW 050 100 16 **60**

Thermostaatkop

Verwarmen *

COLO VBCF JW 4 ..	JW	
COLO VBCF AC 4 ..	AC	
COLO VBCF AW 4 ..	AW	
COLO VBCF AS 4 ..	AS	
COLO VBCF AB 4 ..	AB	
COLO VBCF JH 4 ..	JH	

Verwarmen en koelen

COLO VBCF MA 4 ..	MA	
COLO VBCF HC 4 ..	HC	

Code klemkoppeling invullen

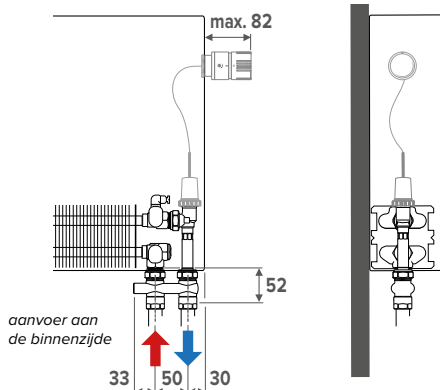

SET 112



Naar de vloer
Vanop afstand bediend
Aanvoer binnenzijde
Kv 0.1 - 0.6 m³/u bij Δp = 1 bar
KVS 0.8
Tweepijp

De radiator heeft geen opening voor een thermostaatkop nodig; hiervoor dient u de aansluitcode te wijzigen naar /00.
Vb.: STRW 050 100 16 **00**

Thermostaatkop

Verwarmen *

COLO VBCF RD 4 ..	RD	
COLO VBCF RW 4 ..	RW	

Verwarmen en koelen

COLO VBCF 24 4 ..	24 (24 VDC)	
COLO VBCF 23 4 ..	23 (230 VAC)	

Code klemkoppeling invullen

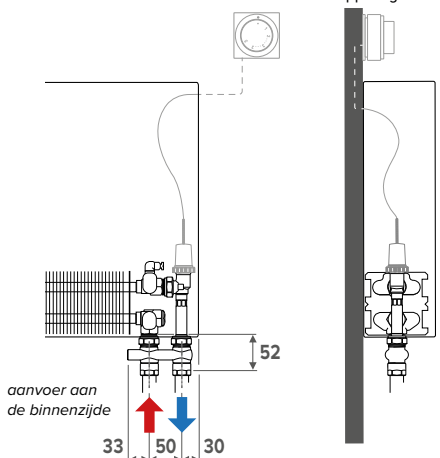

STRADA TYPE 06	STRADA TYPE 10 < 21	LINEA PLUS	TEMPO	MINI WAND H 008	MINI WAND H 013 < 028	KNOCKONWOOD TYPE 06	KNOCKONWOOD TYPE 10 < 21	WANDINBOUW	MINI VRIJSTAAND	LINEA PLUS VRIJSTAAND	TEMPO VRIJSTAAND	STRADA HYBRID	WANDINBOUW HYBRID
✓	✓	✓	✓	-	✓	-	✓	✓	-	-	-	✓	✓
✓	✓	✓	✓	-	✓	-	✓	✓	-	-	-	✓	✓
✓	✓	✓	✓	-	✓	-	✓	✓	-	-	-	✓	✓
✓	✓	✓	✓	-	✓	-	✓	✓	-	-	-	✓	✓
✓	✓	✓	✓	-	✓	-	✓	✓	-	-	-	✓	✓
✓	✓	✓	✓	-	✓	-	✓	✓	-	-	-	✓	✓
✓	✓	✓	✓	-	✓	-	✓	✓	-	-	-	✓	✓
✓	✓	✓	✓	-	✓	-	✓	✓	-	-	-	✓	✓
✓	✓	✓	✓	-	✓	-	✓	✓	-	-	-	✓	✓
✓	✓	✓	✓	-	✓	-	✓	✓	-	-	-	✓	✓
✓	✓	✓	✓	-	✓	-	✓	✓	-	-	-	✓	✓
✓	✓	✓	✓	-	✓	-	✓	✓	-	-	-	✓	✓

KLEMKOPPELINGEN EUROCONUS

Bestelvoorbeeld

Bestelcode aansluitset aanvullen met code klemkoppelingen volgens gebruikte buis en Ø.
Inbegrepen in de prijs van de aansluitsets.

code aansluitset code klemkoppeling
COLO VBCF JW 4 **112**

Dunwandig metaal

CODE	BUIS Ø
112	12/1
114	14/1
115	15/1
116	16/1
118	18/1

Kunststof of VPE/ALU

CODE	BUIS Ø	CODE	BUIS Ø
612	12/2	615	15/2.5
614	14/2	619	16/1.5
616	16/2	620	20/2
618	18/2		

AANSLUITSETS EUROCONUS

NAAR DE WAND BINNEN DE BEKLEDING

* Ook geschikt voor Light Cooling in combinatie met adapter 5090 1114.

SET 225



Naar de wand
Bediening beneden
Kv 0.1 - 0.6 m³/u bij Δp = 1 bar
KVS 0.8
Tweepijp

Thermostaatkop

Verwarmen *

Model	Type	Image
COLO SW2 JW 4 ..	JW	
COLO SW2 AC 4 ..	AC	
COLO SW2 AW 4 ..	AW	
COLO SW2 AS 4 ..	AS	
COLO SW2 AB 4 ..	AB	
COLO SW2 JH 4 ..	JH	

Verwarmen en koelen

COLO SW2 MA 4 ..	MA	
COLO SW2 HC 4 ..	HC	

Code klemkoppeling invullen

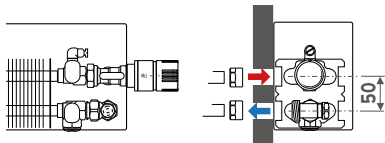

NIEUW

SET 285

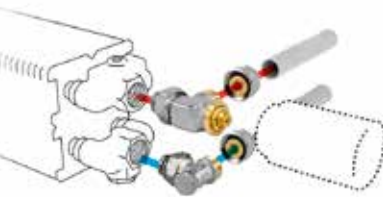

Naar de wand
Bediening beneden
Automatische debietregeling (20 - 340 l/u)
Tweepijp

Thermostaatkop

Verwarmen *

Model	Type	Image
COLO GW2 JW 4 ..	JW	
COLO GW2 AC 4 ..	AC	
COLO GW2 AW 4 ..	AW	
COLO GW2 AS 4 ..	AS	
COLO GW2 AB 4 ..	AB	
COLO GW2 JH 4 ..	JH	

Verwarmen en koelen

COLO GW2 MA 4 ..	MA	
COLO GW2 HC 4 ..	HC	

Code klemkoppeling invullen

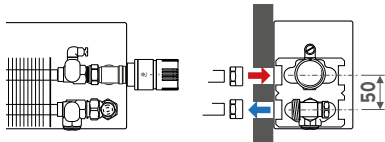

SET 226

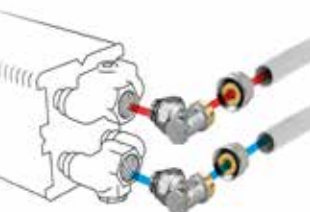

Naar de wand
Geen bediening
Tweepijp

COLO LOA 00 4 ..

Code klemkoppeling invullen

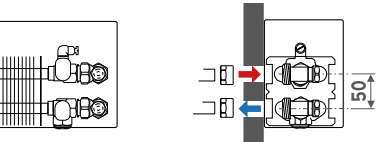

De juiste positie van de bediening in de code opgeven.
30 (links) of **60** (rechts)
Vb.: STRW 050 100 16 **60**

KLEMKOPPELINGEN EUROCONUS

BESTELVOORBEELD

Bestelcode aansluitset aanvullen met code klemkoppelingen volgens gebruikte buis en Ø. Inbegrepen in de prijs van de aansluitsets.

code aansluitset code klemkoppeling
COLO SW2 JW 4 112

Dunwandig metaal

CODE	BUIS Ø
112	12/1
114	14/1
115	15/1
116	16/1
118	18/1

Kunststof of VPE/ALU

CODE	BUIS Ø	CODE	BUIS Ø
612	12/2	615	15/2.5
614	14/2	619	16/1.5
616	16/2	620	20/2
618	18/2		

	STRADA TYPE 06	STRADA TYPE 10 < 21	LINEA PLUS	TEMPO	MINI WAND H 008	MINI WAND H 013 < 028	KNOCKONWOOD TYPE 06	KNOCKONWOOD TYPE 10 < 21	WANDINBOUW	MINI VRIJSTAAND	LINEA PLUS VRIJSTAAND	TEMPO VRIJSTAAND	STRADA HYBRID	WANDINBOUW HYBRID
SET 225	✓	✓	✓	✓	-	✓	✓	✓	✓	-	-	-	✓	✓
SET 285	-	✓	✓	✓	-	✓	-	✓	✓	-	-	-	✓	✓
SET 226	-	✓	✓	✓	-	✓	-	✓	✓	-	-	-	✓	✓

AANSLUITSETS EUROCONUS

NAAR DE VLOER

* Ook geschikt voor Light Cooling in combinatie met adapter 5090 1114.

SET 222

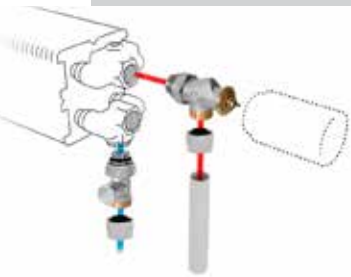

Naar de vloer
Bediening beneden
Aanvoer buitenzijde
Kv 0.1 - 0.6 m³/u bij Δp = 1 bar
KVS 0.8
Tweepijp

Thermostaatkop

Verwarmen *

COLO JF2 JW 4 ..	JW	
COLO JF2 AC 4 ..	AC	
COLO JF2 AW 4 ..	AW	
COLO JF2 AS 4 ..	AS	
COLO JF2 AB 4 ..	AB	
COLO JF2 JH 4 ..	JH	

Verwarmen en koelen

COLO JF2 MA 4 ..	MA	
COLO JF2 HC 4 ..	HC	

Code klemkoppeling invullen

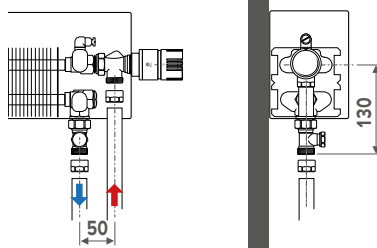

NIEUW

SET 282

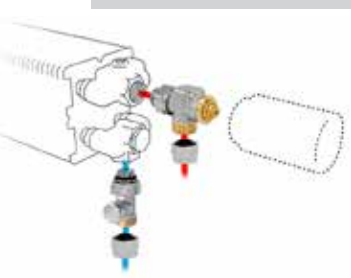

Naar de vloer
Bediening beneden
Aanvoer buitenzijde
Automatische debietregeling (20 - 340 l/u)
Tweepijp

Thermostaatkop

Verwarmen *

COLO GF2 JW 4 ..	JW	
COLO GF2 AC 4 ..	AC	
COLO GF2 AW 4 ..	AW	
COLO GF2 AS 4 ..	AS	
COLO GF2 AB 4 ..	AB	
COLO GF2 JH 4 ..	JH	

Verwarmen en koelen

COLO GF2 MA 4 ..	MA	
COLO GF2 HC 4 ..	HC	

Code klemkoppeling invullen

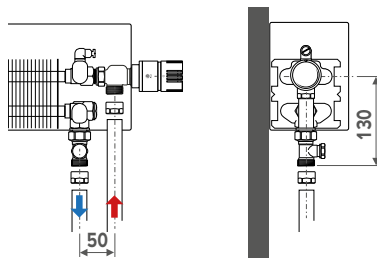

	STRADA	LINEA PLUS	TEMPO	MINI WAND H 008	MINI WAND H 013 < 028	KNOCKONWOOD	WANDINBOUW	MINI VRIJSTAAND H 008	MINI VRIJSTAAND H 013 < 028	LINEA PLUS VRIJSTAAND	TEMPO VRIJSTAAND	STRADA HYBRID	WANDINBOUW HYBRID
COLO JF2 JW 4 ..	✓	✓	✓	-	✓	✓	✓	-	✓	✓	✓	✓	✓
COLO JF2 AC 4 ..	✓	✓	✓	-	✓	✓	✓	-	✓	✓	✓	✓	✓
COLO JF2 AW 4 ..	✓	✓	✓	-	✓	✓	✓	-	✓	✓	✓	✓	✓
COLO JF2 AS 4 ..	✓	✓	✓	-	✓	✓	✓	-	✓	✓	✓	✓	✓
COLO JF2 AB 4 ..	✓	✓	✓	-	✓	✓	✓	-	✓	✓	✓	✓	✓
COLO JF2 JH 4 ..	✓	✓	✓	-	✓	✓	✓	-	✓	✓	✓	✓	✓
COLO JF2 MA 4 ..	✓	✓	✓	-	✓	✓	✓	-	✓	✓	✓	✓	✓
COLO JF2 HC 4 ..	-	-	-	-	-	-	-	-	-	-	✓	✓	✓
COLO GF2 JW 4 ..	✓	✓	✓	-	✓	✓	✓	-	✓	✓	✓	✓	✓
COLO GF2 AC 4 ..	✓	✓	✓	-	✓	✓	✓	-	✓	✓	✓	✓	✓
COLO GF2 AW 4 ..	✓	✓	✓	-	✓	✓	✓	-	✓	✓	✓	✓	✓
COLO GF2 AS 4 ..	✓	✓	✓	-	✓	✓	✓	-	✓	✓	✓	✓	✓
COLO GF2 AB 4 ..	✓	✓	✓	-	✓	✓	✓	-	✓	✓	✓	✓	✓
COLO GF2 JH 4 ..	✓	✓	✓	-	✓	✓	✓	-	✓	✓	✓	✓	✓
COLO GF2 MA 4 ..	✓	✓	✓	-	✓	✓	✓	-	✓	✓	✓	✓	✓
COLO GF2 HC 4 ..	-	-	-	-	-	-	-	-	-	-	✓	✓	✓

KLEMKOPPELINGEN EUROCONUS

Bestelvoorbeeld

Bestelcode aansluitset aanvullen met code klemkoppelingen volgens gebruikte buis en Ø. Inbegrepen in de prijs van de aansluitsets.

code aansluitset code klemkoppeling
COLO JF2 JW 4 112

Dunwandig metaal

CODE	BUIS Ø
112	12/1
114	14/1
115	15/1
116	16/1
118	18/1

Kunststof of VPE/ALU

CODE	BUIS Ø	CODE	BUIS Ø
612	12/2	615	15/2.5
614	14/2	619	16/1.5
616	16/2	620	20/2
618	18/2		

AANSLUITSETS EUROCONUS

AANSLUITING IN DE VLOERPUT

* Ook geschikt voor Light Cooling in combinatie met adapter 5090 1114.

SET 271



Vloerinbouw
Kv 0.1 - 0.6 m³/u bij Δp = 1 bar
KVS 0.8
Tweepijp

Thermostaatkop

Verwarmen *

COMC JH2 AB 4 ..	AB	
COMC JH2 RD 4 ..	RD	
COMC JH2 RW 4 ..	RW	

Verwarmen en koelen

COMC JH2 MA 4 ..	MA	
COMC JH2 24 4 ..	24 (24 VDC)	
COMC JH2 23 4 ..	23 (230 VAC)	

Code klemkoppeling invullen



SET 272



Vloerinbouw
Kv 0.1 - 0.6 m³/u bij Δp = 1 bar
KVS 0.8
Tweepijp

Thermostaatkop

Verwarmen *

COMC JV2 AB 4 ..	AB	
COMC JV2 RD 4 ..	RD	
COMC JV2 RW 4 ..	RW	

Verwarmen en koelen

COMC JV2 MA 4 ..	MA	
COMC JV2 24 4 ..	24 (24 VDC)	
COMC JV2 23 4 ..	23 (230 VAC)	

Code klemkoppeling invullen

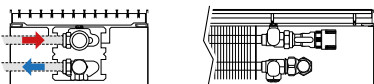

MINI CANAL H009	MINI CANAL H011	MINI CANAL H014	MINI CANAL H019	MINI CANAL PRO H009	MINI CANAL PRO H011	MINI CANAL PRO H014	MINI CANAL PRO H019	MINI CANAL HYBRID H014
✓	✓	-	-	✓	✓	-	-	-
✓	✓	-	-	✓	✓	-	-	-
✓	✓	-	-	✓	✓	-	-	-
✓	✓	-	-	✓	✓	-	-	-
✓	✓	-	-	✓	✓	-	-	-
-	-	✓	✓	-	-	✓	✓	✓
-	-	✓	✓	-	-	✓	✓	✓
-	-	✓	✓	-	-	✓	✓	✓
-	-	✓	✓	-	-	✓	✓	✓

KLEMKOPPELINGEN EUROCONUS

BESTELVOORBEELD

Bestelcode aansluitset aanvullen met code klemkoppelingen volgens gebruikte buis en Ø. Inbegrepen in de prijs van de aansluitsets.

code aansluitset code klemkoppeling
COMC JH2 AB 4 112

Dunwandig metaal

CODE	BUIS Ø
112	12/1
114	14/1
115	15/1
116	16/1
118	18/1

Kunststof of VPE/ALU

CODE	BUIS Ø
612	12/2
614	14/2
616	16/2
618	18/2

AANSLUITSETS EUROCONUS

NAAR DE WAND

SET 295



Naar de wand
Kv 0.1 - 0.6 m³/u bij Δp = 1 bar
KVS 0.8
Tweepijp

Thermostaatkop

Verwarmen en koelen

CODY SC5 24 4 ..	24 (24 VDC)	
CODY SC5 23 4 ..	23 (230 VAC)	

Code klemkoppeling invullen

SET 290



Naar de wand
Kv 0.15 - 1.35 m³/u bij Δp = 1 bar
Tweepijp

Thermostaatkop

Verwarmen en koelen

CODY LOC 00 4 ..		
------------------	--	--

Code klemkoppeling invullen

BRIZA 12	1ste warmtewisselaar	✓	✓	-	-	-	-
BRIZA 12	2e warmtewisselaar	✓	✓	-	-	-	-
BRIZA 22	1ste warmtewisselaar	-	-	-	-	-	-
BRIZA 22	2e warmtewisselaar	-	-	-	-	-	-
BRIZA 26	1ste warmtewisselaar	-	-	-	-	-	-
BRIZA 26	2e warmtewisselaar	-	-	-	-	-	-

KLEMKOPPELINGEN EUROCONUS

BESTELVOORBEELD

Bestelcode aansluitset aanvullen met code klemkoppelingen volgens gebruikte buis en Ø.
Inbegrepen in de prijs van de aansluitsets.

code aansluitset code klemkoppeling
CODY SC5 24 4 112

Dunwandig metaal

CODE	BUIS Ø
112	12/1
114	14/1
115	15/1
116	16/1
118	18/1

Kunststof of VPE/ALU

CODE	BUIS Ø
612	12/2
614	14/2
616	16/2
618	18/2

CODE	BUIS Ø
615	15/2.5
619	16/1.5
620	20/2

AANSLUITSETS EUROCONUS



SET 298



Kv 1.0 m³/u bij Δp = 1 bar
Zonder voorinstelling
Tweepijp

Thermostaatkop

Verwarmen en koelen

CODY WA4 24 0	24 (24 VDC)	
CODY WA4 23 0	23 (230 VAC)	

SET 99



Kv 0.15 - 1.35 m³/u bij Δp = 1 bar
Tweepijp

Verwarmen en koelen

CODY LOM 00 0		
---------------	--	--

BRIZA 12	1ste warmtewisselaar	·	·	·	·	·	·	·	·
BRIZA 12	2e warmtewisselaar	·	·	·	·	·	·	·	·
BRIZA 22	1ste warmtewisselaar	·	·	·	·	·	·	·	·
BRIZA 22	2e warmtewisselaar	·	·	·	·	·	·	·	·
BRIZA 26	1ste warmtewisselaar	·	·	·	·	·	·	·	·
BRIZA 26	2e warmtewisselaar	·	·	·	·	·	·	·	·
BRIZA 26	1ste warmtewisselaar	·	·	·	·	·	·	·	·
BRIZA 26	2e warmtewisselaar	·	·	·	·	·	·	·	·

AANSLUITSETS EUROCONUS



SET 294



Naar de vloer
Kv 0.1 - 0.6 m³/u bij Δp = 1 bar
KVS 0.8
Tweepijp

Thermostaatkop

Verwarmen en koelen

CODY AA4 24 4 ..	24 (24 VDC)	
CODY AA4 10 4 ..	10 (0 ..10 VDC)	

Code klemkoppeling invullen

SET 291



Naar de vloer
Kv 0.15 - 1.35 m³/u bij Δp = 1 bar
Tweepijp

Verwarmen en koelen

CODY LOS 00 4 ..	
------------------	--

Code klemkoppeling invullen

FREEDOM

✓

✓

✓

KLEMKOPPELINGEN EUROCONUS

BESTELVOORBEELD

Bestelcode aansluitset aanvullen met code klemkoppelingen volgens gebruikte buis en Ø. Inbegrepen in de prijs van de aansluitsets.

code aansluitset code klemkoppeling
CODY AA4 24 4 112

Dunwandig metaal

CODE	BUIS Ø
112	12/1
114	14/1
115	15/1
116	16/1
118	18/1

Kunststof of VPE/ALU

CODE	BUIS Ø	CODE	BUIS Ø
612	12/2	615	15/2.5
614	14/2	619	16/1.5
616	16/2	620	20/2
618	18/2		

AANSLUITSETS EUROCONUS

SET 297

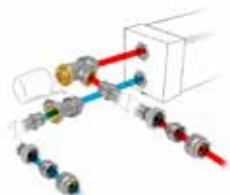

Kv 0.1 - 0.6 m³/u bij Δp = 1 bar
KVS 0.8
Tweepijp
Aansluitflexibels worden samen met het toestel geleverd

Thermostaatkop

Verwarmen en koelen

CODY JA4 24 4 ..	24 (24 VDC)	
CODY JA4 10 4 ..	10 (0 ..10 VDC)	
Code klemkoppeling invullen		

SET 298

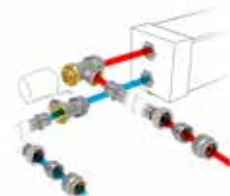

Kv 1.0 m³/u bij Δp = 1 bar
Zonder voorinstelling
Tweepijp
Aansluitflexibels worden samen met het toestel geleverd

Thermostaatkop

Verwarmen en koelen

CODY WA4 24 4 ..	24 (24 VDC)	
CODY WA4 10 4 ..	10 (0 ..10 VDC)	
Code klemkoppeling invullen		

SET 299



Kv 0.15 - 1.35 m³/u bij Δp = 1 bar
Tweepijp
Aansluitflexibels worden samen met het toestel geleverd

Verwarmen en koelen

CODY LOM 00 4 ..		
Code klemkoppeling invullen		

CLIMA CANAL H08/10
CLIMA CANAL H13
CLIMA CANAL H19
CLIMA BEAM

✓	✓	-	✓
✓	✓	-	✓
✓	✓	✓	✓
✓	✓	✓	✓
✓	✓	✓	✓

KLEMKOPPELINGEN EUROCONUS

BESTELVOORBEELD

Bestelcode aansluitset aanvullen met code klemkoppelingen volgens gebruikte buis en Ø. Inbegrepen in de prijs van de aansluitsets.

code aansluitset	code klemkoppeling
CODY JA4 24 4	112

Dunwandig metaal

CODE	BUIS Ø
112	12/1
114	14/1
115	15/1
116	16/1
118	18/1

Kunststof of VPE/ALU

CODE	BUIS Ø	CODE	BUIS Ø
612	12/2	615	15/2.5
614	14/2	619	16/1.5
616	16/2	620	20/2
618	18/2		

AANSLUITSETS DN20 G 3/4"

SET 303

Zonder klemkoppelingen

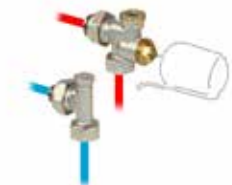

Met klemkoppelingen



Aanvoer: Kv 3.4 m³/u bij Δp = 1 bar
 Retour: Kv 0.8 - 2.5 m³/u bij Δp = 1 bar
 Tweepijp

Thermostaatkop

Verwarmen en koelen

Zonder klemkoppelingen

CODY WAA 24 0 24 (24 VDC)

CODY WAA 23 0 23 (230 VAC)

Met klemkoppelingen

CODY WAA 24 4 ... 24 (24 VDC)

CODY WAA 23 4 ... 23 (230 VAC)

Code klemkoppeling invullen

✓
✓
✓
✓

SET 304

Zonder klemkoppelingen



Met klemkoppelingen



Kv 0.8 - 2.5 m³/u bij Δp = 1 bar
 Tweepijp

Thermostaatkop

Verwarmen en koelen

Zonder klemkoppelingen

CODY LOA 00 0

Met klemkoppelingen

CODY LOA 00 4 ...

Code klemkoppeling invullen

✓
✓

KLEMKOPPELINGEN EUROCONUS

BESTELVOORBEELD

Bestelcode aansluitset aanvullen met code klemkoppelingen volgens gebruikte buis en Ø. Inbegrepen in de prijs van de aansluitsets.

code aansluitset code klemkoppeling
 CODY WAA 24 4 112

Dunwandig metaal

CODE	BUIS Ø
112	12/1
114	14/1
115	15/1
116	16/1
118	18/1

Kunststof of VPE/ALU

CODE	BUIS Ø	CODE	BUIS Ø
612	12/2	615	15/2.5
614	14/2	619	16/1.5
616	16/2	620	20/2
618	18/2		

AANSLUITSETS DN20 G 3/4"

NAAR DE WAND

SET 301

Zonder klemkoppelingen



Met klemkoppelingen



Aanvoer: Kv 3.4 m³/u bij Δp = 1 bar
Retour: Kv 0.8 - 2.5 m³/u bij Δp = 1 bar
Tweepijp

Thermostaatkop

Verwarmen en koelen

Zonder klemkoppelingen

CODY WAA 24 0 24 (24 VDC) 

CODY WAA 23 0 23 (230 VAC) 

Met klemkoppelingen

CODY WAA 24 4 ... 24 (24 VDC) 

CODY WAA 23 4 ... 23 (230 VAC) 

Code klemkoppeling invullen

SET 302

Zonder klemkoppelingen



Met klemkoppelingen



Kv 0.8 - 2.5 m³/u bij Δp = 1 bar
Tweepijp

Thermostaatkop

Verwarmen en koelen

Zonder klemkoppelingen

CODY LO5 00 0

Met klemkoppelingen

CODY LO5 00 4 ...

Code klemkoppeling invullen

BRIZA 12 1ste warmtewisselaar	BRIZA 12 2e warmtewisselaar	BRIZA 22 1ste warmtewisselaar	BRIZA 22 2e warmtewisselaar	BRIZA 26 1ste warmtewisselaar	BRIZA 26 2e warmtewisselaar
-	-	✓	-	✓	-
-	-	✓	-	✓	-
-	-	✓	-	✓	-
-	-	✓	-	✓	-

KLEMKOPPELINGEN EUROCONUS

BESTELVOORBEELD

Bestelcode aansluitset aanvullen met code klemkoppelingen volgens gebruikte buis en Ø. Inbegrepen in de prijs van de aansluitsets.

code aansluitset code klemkoppeling
CODY WAA 24 4 112

Dunwandig metaal

CODE	BUIS Ø
112	12/1
114	14/1
115	15/1
116	16/1
118	18/1

Kunststof of VPE/ALU

CODE	BUIS Ø
612	12/2
614	14/2
616	16/2
618	18/2
615	15/2.5
619	16/1.5
620	20/2

AANSLUITSETS M24

NAAR DE WAND MET JAGA PRO VENTIEL

* Ook geschikt voor Light Cooling in combinatie met adapter 5090 1114.

SET 11

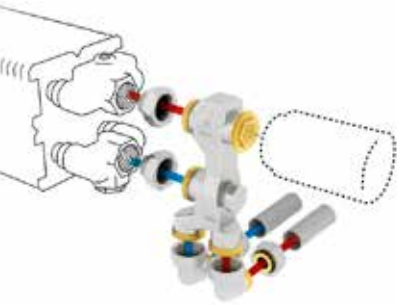

Naar de wand
Bediening beneden
Aanvoer buitenzijde
Kv 0.07 - 0.6 m³/u bij Δp = 1 bar
KVS 0.8
Tweepijp

Thermostaatkop

Verwarmen *

COLO PW2 JW 3...	JW	
COLO PW2 AC 3...	AC	
COLO PW2 AW 3...	AW	
COLO PW2 AS 3...	AS	
COLO PW2 AB 3...	AB	
COLO PW2 JH 3...	JH	

Verwarmen en koelen

COLO PW2 MA 3...	MA	
COLO PW2 HC 3...	HC	

Code klemkoppeling invullen

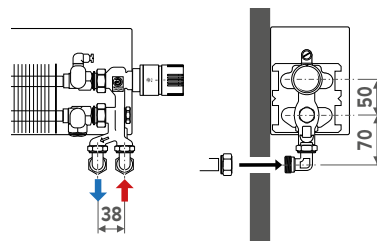

SET 13

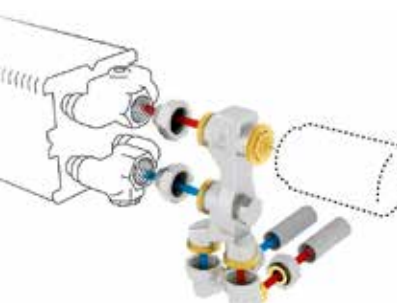

Naar de wand
Bediening beneden
Aanvoer buitenzijde
Kv 0.07 - 0.6 m³/u bij Δp = 1 bar
KVS 0.8
Eénpijp

Thermostaatkop

Verwarmen *

COLO PW1 JW 3...	JW	
COLO PW1 AC 3...	AC	
COLO PW1 AW 3...	AW	
COLO PW1 AS 3...	AS	
COLO PW1 AB 3...	AB	
COLO PW1 JH 3...	JH	

Verwarmen en koelen

COLO PW1 MA 3...	MA	
COLO PW1 HC 3...	HC	

Code klemkoppeling invullen

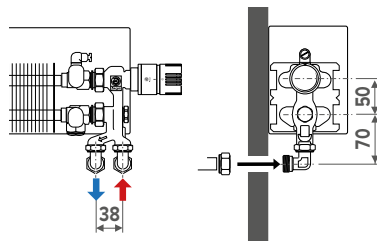

	STRADA	LINEA PLUS	TEMPO	MINI WAND H 008	MINI WAND H 013 < 028	KNOCKONWOOD	WANDINBOUW	MINI VRIJSTAAND H 008	MINI VRIJSTAAND H 013 < 028	LINEA PLUS VRIJSTAAND	TEMPO VRIJSTAAND	STRADA HYBRID	WANDINBOUW HYBRID
Verwarmen *	✓	✓	✓	-	✓	✓	✓	-	-	-	-	✓	✓
Verwarmen en koelen	✓	✓	✓	-	✓	✓	✓	-	-	-	-	✓	✓

KLEMKOPPELINGEN M24

BESTELVOORBEELD

Bestelcode aansluitset aanvullen met code klemkoppelingen volgens gebruikte buis en Ø. Inbegrepen in de prijs van de aansluitsets.

code aansluitset code klemkoppeling
COLO PW2 JW 3 110

Dunwandig metaal

CODE	BUIS Ø
110	10/1
112	12/1
114	14/1
115	15/1
116	16/1
118	18/1

Kunststof

CODE	BUIS Ø
212	12/2
214	14/2
219	16/1.5
216	16/2
217	17/2
218	18/2

VPE/ALU

CODE	BUIS Ø
314	14/2
316	16/2
326	16/2.2
318	18/2

Stalen c.v. buis

CODE	BUIS Ø
501	M24 x 1/2"
503	M24 x 3/8"

AANSLUITSETS M24

NAAR DE VLOER MET JAGA PRO VENTIEL

* Ook geschikt voor Light Cooling in combinatie met adapter 5090 1114.

SET 12

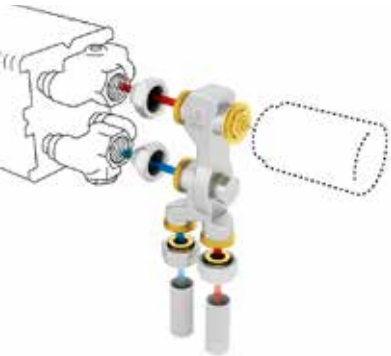

Naar de vloer
Bediening beneden
Aanvoer buitenzijde
Kv 0.07 - 0.6 m³/u bij Δp = 1 bar
KVS 0.8
Tweepijp

Thermostaatkop

Verwarmen *

COLO PF2 JW 3...	JW	
COLO PF2 AC 3...	AC	
COLO PF2 AW 3...	AW	
COLO PF2 AS 3...	AS	
COLO PF2 AB 3...	AB	
COLO PF2 JH 3...	JH	

Verwarmen en koelen

COLO PF2 MA 3...	MA	
COLO PF2 HC 3...	HC	

Code klemkoppeling invullen

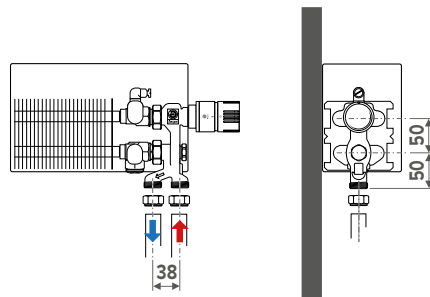

SET 14



Naar de vloer
Bediening beneden
Aanvoer buitenzijde
Kv 0.07 - 0.6 m³/u bij Δp = 1 bar
KVS 0.8
Éénpijp

Thermostaatkop

Verwarmen *

COLO PF1 JW 3...	JW	
COLO PF1 AC 3...	AC	
COLO PF1 AW 3...	AW	
COLO PF1 AS 3...	AS	
COLO PF1 AB 3...	AB	
COLO PF1 JH 3...	JH	

Verwarmen en koelen

COLO PF1 MA 3...	MA	
COLO PF1 HC 3...	HC	

Code klemkoppeling invullen

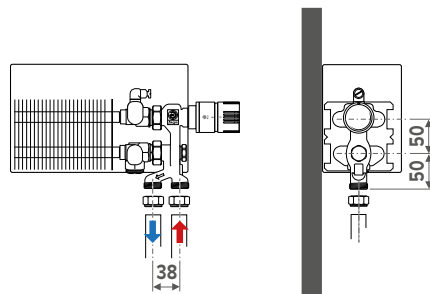

STRADA	LINEA PLUS	TEMPO	MINI WAND H 008	MINI WAND H 013 < 028	KNOCKONWOOD	WANDINBOUW	MINI VRIJSTAAND H 008	MINI VRIJSTAAND H 013 < 028	LINEA PLUS VRIJSTAAND	TEMPO VRIJSTAAND	STRADA HYBRID	WANDINBOUW HYBRID
✓	✓	✓	-	✓	✓	✓	-	✓	✓	✓	✓	✓
✓	✓	✓	-	✓	✓	✓	-	✓	✓	✓	✓	✓
✓	✓	✓	-	✓	✓	✓	-	✓	✓	✓	✓	✓
✓	✓	✓	-	✓	✓	✓	-	✓	✓	✓	✓	✓
✓	✓	✓	-	✓	✓	✓	-	✓	✓	✓	✓	✓
✓	✓	✓	-	✓	✓	✓	-	✓	✓	✓	✓	✓
✓	✓	✓	-	✓	✓	✓	-	✓	✓	✓	✓	✓
✓	✓	✓	-	✓	✓	✓	-	✓	✓	✓	✓	✓
-	-	-	-	-	-	-	-	-	-	-	✓	✓

KLEMKOPPELINGEN M24

BESTELVOORBEELD

Bestelcode aansluitset aanvullen met code klemkoppelingen volgens gebruikte buis en Ø. Inbegrepen in de prijs van de aansluitsets.

code aansluitset code klemkoppeling
COLO PF2 JW 3 110

Dunwandig metaal

CODE	BUIS Ø
110	10/1
112	12/1
114	14/1
115	15/1
116	16/1
118	18/1

Kunststof

CODE	BUIS Ø
212	12/2
214	14/2
219	16/1.5
216	16/2
217	17/2
218	18/2

VPE/ALU

CODE	BUIS Ø
314	14/2
316	16/2
326	16/2.2
318	18/2

Stalen c.v. buis

CODE	BUIS Ø
501	M24 x 1/2"
503	M24 x 3/8"

AANSLUITSETS M24

NAAR DE WAND MET JAGA VENTIEL

* Ook geschikt voor Light Cooling in combinatie met adapter 5090 1114.

SET 25



Naar de wand
Bediening beneden
Kv 0.1 - 0.6 m³/u bij Δp = 1 bar
KVS 0.8
Tweepijp

Thermostaatkop

Verwarmen *

COLO SW2 JW 3...	JW	
COLO SW2 AC 3...	AC	
COLO SW2 AW 3...	AW	
COLO SW2 AS 3...	AS	
COLO SW2 AB 3...	AB	
COLO SW2 JH 3...	JH	

Verwarmen en koelen

COLO SW2 MA 3...	MA	
COLO SW2 HC 3...	HC	

Code klemkoppeling invullen

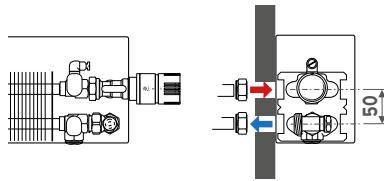

STRADA TYPE 06	STRADA TYPE 10 < 21	LINEA PLUS	TEMPO	MINI WAND H 008	MINI WAND H 013 < 028	KNOCKONWOOD TYPE 06	KNOCKONWOOD TYPE 10 < 21	WANDINBOUW	MINI VRIJSTAAND	LINEA PLUS VRIJSTAAND	TEMPO VRIJSTAAND	STRADA HYBRID	WANDINBOUW HYBRID
✓	✓	✓	✓	-	-	✓	✓	✓	-	-	-	✓	✓
✓	✓	✓	✓	-	-	✓	✓	✓	-	-	-	✓	✓
✓	✓	✓	✓	-	-	✓	✓	✓	-	-	-	✓	✓
✓	✓	✓	✓	-	-	✓	✓	✓	-	-	-	✓	✓
✓	✓	✓	✓	-	-	✓	✓	✓	-	-	-	✓	✓
✓	✓	✓	✓	-	-	✓	✓	✓	-	-	-	✓	✓
-	-	-	-	-	-	-	-	-	-	-	-	✓	✓
-	-	-	-	-	-	-	-	-	-	-	-	✓	✓

KLEMKOPPELINGEN M24

BESTELVOORBEELD

Bestelcode aansluitset aanvullen met code klemkoppelingen volgens gebruikte buis en Ø. Inbegrepen in de prijs van de aansluitsets.

code aansluitset code klemkoppeling
COLO SW2 JW 3 110

Dunwandig metaal

CODE	BUIS Ø
110	10/1
112	12/1
114	14/1
115	15/1
116	16/1
118	18/1

Kunststof

CODE	BUIS Ø
212	12/2
214	14/2
219	16/1.5
216	16/2
217	17/2
218	18/2

VPE/ALU

CODE	BUIS Ø
314	14/2
316	16/2
326	16/2.2
318	18/2

Stalen c.v. buis

CODE	BUIS Ø
501	M24 x 1/2"
503	M24 x 3/8"

AANSLUITSETS M24

NAAR DE WAND

* Ook geschikt voor Light Cooling in combinatie met adapter 5090 1114.

SET 28

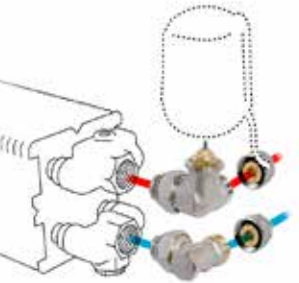

Naar de wand
Bediening beneden
Aansluiting rechts
Kv 0.1 - 0.6 m³/u bij Δp = 1 bar
KVS 0.8
Tweepijp

De radiator heeft geen opening voor een thermostaatkop nodig; hiervoor dient u de aansluitcode te wijzigen naar /00.
Vb.: STRW 050 100 16 00

Thermostaatkop

Verwarmen *

COLO HWR RD 3....	RD	
COLO HWR RW 3....	RW	
Verwarmen en koelen		
COLO HWR MA 3....	MA	
COLO HWR 24 3....	24 (24 VDC)	
COLO HWR 23 3....	23 (230 VAC)	

Code klemkoppeling invullen

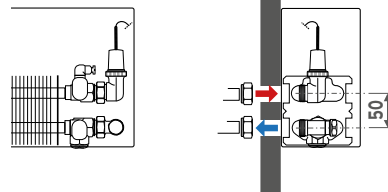

SET 29

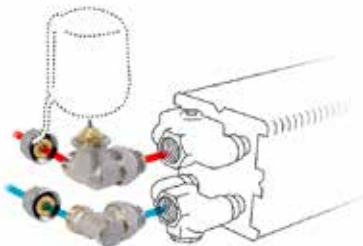

Naar de wand
Bediening beneden
Aansluiting links
Kv 0.1 - 0.6 m³/u bij Δp = 1 bar
KVS 0.8
Tweepijp

De radiator heeft geen opening voor een thermostaatkop nodig; hiervoor dient u de aansluitcode te wijzigen naar /00.
Vb.: STRW 050 100 16 00

Thermostaatkop

Verwarmen *

COLO HWL RD 3....	RD	
COLO HWL RW 3....	RW	
Verwarmen en koelen		
COLO HWL MA 3....	MA	
COLO HWL 24 3....	24 (24 VDC)	
COLO HWL 23 3....	23 (230 VAC)	

Code klemkoppeling invullen

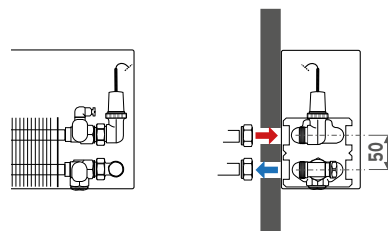

	STRADA	LINEA PLUS	TEMPO	MINI WAND	KNOCKONWOOD	WANDINBOUW	MINI VRIJSTAAND	LINEA PLUS VRIJSTAAND	TEMPO VRIJSTAAND	STRADA HYBRID	WANDINBOUW HYBRID
Verwarmen *											
COLO HWR RD 3....	✓	✓	✓	-	✓	✓	-	-	-	✓	✓
COLO HWR RW 3....	✓	✓	✓	-	✓	✓	-	-	-	✓	✓
Verwarmen en koelen											
COLO HWR MA 3....	✓	✓	✓	-	✓	✓	-	-	-	✓	✓
COLO HWR 24 3....	✓	✓	✓	-	✓	✓	-	-	-	✓	✓
COLO HWR 23 3....	✓	✓	✓	-	✓	✓	-	-	-	✓	✓

KLEMKOPPELINGEN M24

BESTELVOORBEELD

Bestelcode aansluitset aanvullen met code klemkoppelingen volgens gebruikte buis en Ø.
Inbegrepen in de prijs van de aansluitsets.

code aansluitset code klemkoppeling
COLO HWR RD 3 110

Dunwandig metaal

CODE	BUIS Ø
110	10/1
112	12/1
114	14/1
115	15/1
116	16/1
118	18/1

Kunststof

CODE	BUIS Ø
212	12/2
214	14/2
219	16/1.5
216	16/2
217	17/2
218	18/2

VPE/ALU

CODE	BUIS Ø
314	14/2
316	16/2
326	16/2.2
318	18/2

Stalen c.v. buis

CODE	BUIS Ø
501	M24 x 1/2"
503	M24 x 3/8"

AANSLUITSETS M24

NAAR DE WAND MET DECO PRO VENTIEL

** Ook geschikt voor Light Cooling in combinatie met adapter 5090 1114.*

SET 41

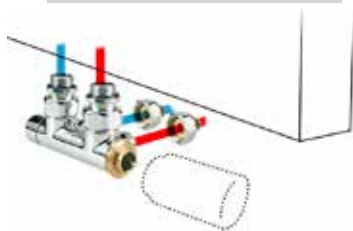

Naar de wand

Tweepijp: Kv 0.29 - 1.61 m³/u bij Δp = 1 bar
KVS 1.65

Éénpijp: Kv 1.50 - 2.20 m³/u bij Δp = 1 bar
KVS 2.20

Thermostaatkop

Verwarmen *

CODE PW3 AC 1...	AC	
CODE PW3 AW 1...	AW	
CODE PW3 AS 1...	AS	
CODE PW3 AB 1...	AB	

Verwarmen en koelen

CODE PW3 HC 1...	HC	
------------------	----	--

Code klemkoppeling invullen

SET 48

VOLLEDIGE SET IN GEBORSTELD ROESTVAST STAAL-LOOK (RVS)



VOLLEDIGE SET IN MATTE ALUMINIUM-LOOK (ALU)



Naar de wand

Tweepijp: Kv 0.29 - 1.61 m³/u bij Δp = 1 bar
KVS 1.65

Éénpijp: Kv 1.50 - 2.20 m³/u bij Δp = 1 bar
KVS 2.20

Thermostaatkop

Verwarmen *

CODE PW3 PS 1...	PS (roestvast staal)	
CODE PW3 PA 1...	PA (aluminium)	

Code klemkoppeling invullen

SANI RONDA	SANI BASIC	IGUANA	TETRA	DECO SPACE	VERTIGA	PANEL PLUS
✓	✓	✓	✓	✓	✓	✓
✓	✓	✓	✓	✓	✓	✓
✓	✓	✓	✓	✓	✓	✓
✓	✓	✓	✓	✓	✓	✓
✓	✓	✓	✓	✓	✓	✓

✓	✓	✓	✓	✓	✓	✓
✓	✓	✓	✓	✓	✓	✓

KLEMKOPPELINGEN M24

Bestelvoorbeeld

Bestelcode aansluitset aanvullen met code klemkoppelingen volgens gebruikte buis en Ø. Inbegrepen in de prijs van de aansluitsets.

code aansluitset code klemkoppeling
CODE PW3 AC 1 110

Dunwandig metaal

CODE	BUIS Ø
110	10/1
112	12/1
114	14/1
115	15/1
118	18/1

Kunststof

CODE	BUIS Ø
212	12/2
219	16/1.5
216	16/2
217	17/2
218	18/2

VPE/ALU

CODE	BUIS Ø
314	14/2
316	16/2
326	16/2.2
318	18/2

Stalen c.v. buis

CODE	BUIS Ø
501	M24 x 1/2"
503	M24 x 3/8"

AANSLUITSETS M24

NAAR DE VLOER MET DECO PRO VENTIEL

* Ook geschikt voor Light Cooling in combinatie met adapter 5090 1114.

SET 42

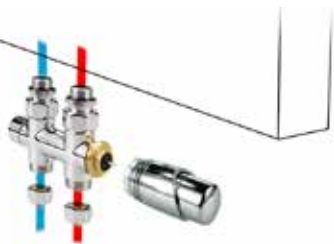

Naar de vloer
Tweepijp: Kv 0.29 - 1.61 m³/u bij Δp = 1 bar
KVS 1.65
Éénpijp: Kv 1.50 - 2.20 m³/u bij Δp = 1 bar
KVS 2.20

Thermostaatkop

Verwarmen *

CODE PF3 AC 1...	AC	
CODE PF3 AW 1...	AW	
CODE PF3 AS 1...	AS	
CODE PF3 AB 1...	AB	

Verwarmen en koelen

CODE PF3 HC 1...	HC	
------------------	----	--

Code klemkoppeling invullen

SET 49

VOLLEDIGE SET IN GEBOSTELD ROESTVAST STAAL-LOOK (RVS)



VOLLEDIGE SET IN MATTE ALUMINIUM-LOOK (ALU)



Naar de vloer
Tweepijp: Kv 0.29 - 1.61 m³/u bij Δp = 1 bar
KVS 1.65
Éénpijp: Kv 1.50 - 2.20 m³/u bij Δp = 1 bar
KVS 2.20

Thermostaatkop

Verwarmen *

CODE PF3 PS 1...	PS (roestvast staal)	
CODE PF3 PA 1...	PA (aluminium)	

Code klemkoppeling invullen

SANI RONDA
SANI BASIC
IGUANA
TETRA
DECO SPACE
VERTIGA
PANEL PLUS

✓	✓	✓	✓	✓	✓	✓
✓	✓	✓	✓	✓	✓	✓
✓	✓	✓	✓	✓	✓	✓
✓	✓	✓	✓	✓	✓	✓
-	-	-	-	-	✓	-
✓	✓	✓	✓	✓	✓	✓
✓	✓	✓	✓	✓	✓	✓

KLEMKOPPELINGEN M24

BESTELVOORBEELD

Bestelcode aansluitset aanvullen met code klemkoppelingen volgens gebruikte buis en Ø. Inbegrepen in de prijs van de aansluitsets.

code aansluitset code klemkoppeling
CODE PF3 AC 1 110

Dunwandig metaal

CODE	BUIS Ø
110	10/1
112	12/1
114	14/1
115	15/1
118	18/1

Kunststof

CODE	BUIS Ø
212	12/2
219	16/1.5
216	16/2
217	17/2
218	18/2

VPE/ALU

CODE	BUIS Ø
314	14/2
316	16/2
326	16/2.2
318	18/2

Stalen c.v. buis

CODE	BUIS Ø
501	M24 x 1/2"
503	M24 x 3/8"

AANSLUITSETS M24

NAAR DE WAND

* Ook geschikt voor Light Cooling in combinatie met adapter 5090 1114.

SET 33

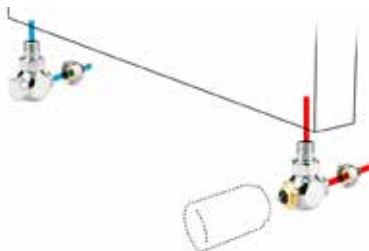

Naar de wand
Haaks
Kv 0.30 - 1.9 m³/u bij Δp = 1 bar
KVS 2.50
Tweepijp

Thermostaatkop

Verwarmen *

CODE JW2 AC 1...	AC	
CODE JW2 AW 1...	AW	
CODE JW2 AS 1...	AS	
CODE JW2 AB 1...	AB	

Code klemkoppeling invullen

SET 36

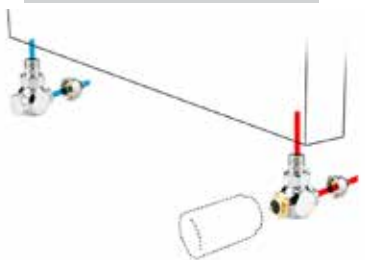

Naar de wand
Haaks
Kleine Kv 0.10 - 0.84 m³/u bij Δp = 1 bar
KVS 0.84
Tweepijp

Thermostaatkop

Verwarmen *

CODE RW2 AC 1...	AC	
CODE RW2 AW 1...	AW	
CODE RW2 AS 1...	AS	
CODE RW2 AB 1...	AB	

Code klemkoppeling invullen

SET 31

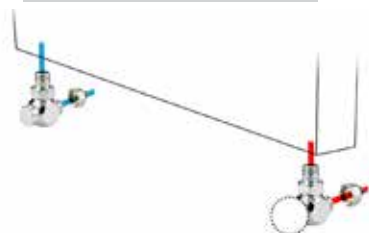

Naar de wand
Haaks handbediend
Tweepijp

Thermostaatkop

Verwarmen *

CODE MW2 MC 1...	MC	
CODE MW2 MW 1...	MW	
CODE MW2 MB 1...	MB	

Code klemkoppeling invullen

PANEL PLUS HORIZONTAAL	SANI RONDA	SANI BASIC	IGUANA	TETRA	DECO SPACE	VERTIGA	PANEL PLUS
✓	✓	✓	✓	✓	✓	✓	✓
✓	✓	✓	✓	✓	✓	✓	✓
✓	✓	✓	✓	✓	✓	✓	✓
✓	✓	✓	✓	✓	✓	✓	✓
✓	✓	✓	-	✓	✓	✓	✓
✓	✓	✓	-	✓	✓	✓	✓
✓	✓	✓	-	✓	✓	✓	✓
✓	✓	✓	-	✓	✓	✓	✓
✓	✓	✓	✓	✓	✓	✓	✓
✓	✓	✓	✓	✓	✓	✓	✓
✓	✓	✓	✓	✓	✓	✓	✓

KLEMKOPPELINGEN M24

BESTELVOORBEELD

Bestelcode aansluitset aanvullen met code klemkoppelingen volgens gebruikte buis en Ø. Inbegrepen in de prijs van de aansluitsets.

code aansluitset code klemkoppeling
CODE JW2 AC 1 110

Dunwandig metaal

CODE	BUIS Ø
110	10/1
112	12/1
114	14/1
115	15/1
118	18/1

Kunststof

CODE	BUIS Ø
212	12/2
219	16/1.5
216	16/2
217	17/2
218	18/2

VPE/ALU

CODE	BUIS Ø
314	14/2
316	16/2
326	16/2.2
318	18/2

Stalen c.v. buis

CODE	BUIS Ø
501	M24 x 1/2"
503	M24 x 3/8"

AANSLUITSETS M24

NAAR DE WAND

** Ook geschikt voor Light Cooling in combinatie met adapter 5090 1114.*

SET 35

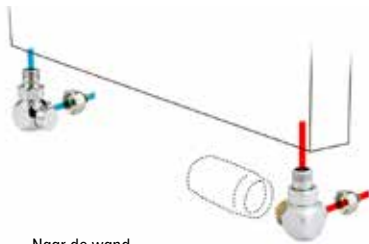

Naar de wand
Dubbel haaks
Kv 0.30 - 1.9 m³/u bij Δp = 1 bar
KVS 2.50
Tweepijp

Thermostaatkop

Verwarmen *

CODE JH2 AC 1...	AC	
CODE JH2 AW 1...	AW	
CODE JH2 AS 1...	AS	
CODE JH2 AB 1...	AB	

Code klemkoppeling invullen

PANEL PLUS HORIZONTAAL	SANI RONDA	SANI BASIC	IGUANA	TETRA	DECO SPACE	VERTIGA	PANEL PLUS
✓	✓	✓	✓	✓	✓	✓	✓
✓	✓	✓	✓	✓	✓	✓	✓
✓	✓	✓	✓	✓	✓	✓	✓
✓	✓	✓	✓	✓	✓	✓	✓

KLEMKOPPELINGEN M24

BESTELVOORBEELD

Bestelcode aansluitset aanvullen met code klemkoppelingen volgens gebruikte buis en Ø. Inbegrepen in de prijs van de aansluitsets.

code aansluitset code klemkoppeling
CODE JH2 AC 1 110

Dunwandig metaal

CODE	BUIS Ø
110	10/1
112	12/1
114	14/1
115	15/1
118	18/1

Kunststof

CODE	BUIS Ø
212	12/2
219	16/1.5
216	16/2
217	17/2
218	18/2

VPE/ALU

CODE	BUIS Ø
314	14/2
316	16/2
326	16/2.2
318	18/2

Stalen c.v. buis

CODE	BUIS Ø
501	M24 x 1/2"
503	M24 x 3/8"

AANSLUITSETS M24

NAAR DE VLOER

** Ook geschikt voor Light Cooling in combinatie met adapter 5090 1114.*

SET 34

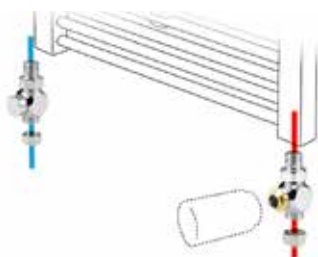

Naar de vloer
Recht
Kv 0.30 - 1.9 m³/u bij Δp = 1 bar
KVS 2.50
Tweepijp

Thermostaatkop

Verwarmen *

CODE JF2 AC 1...	AC	
CODE JF2 AW 1...	AW	
CODE JF2 AS 1...	AS	
CODE JF2 AB 1...	AB	

Code klemkoppeling invullen

SET 32



Naar de vloer
Recht handbediend
Tweepijp

Thermostaatkop

Verwarmen *

CODE MF2 MC 1...	MC	
CODE MF2 MW 1...	MW	
CODE MF2 MB 1...	MB	

Code klemkoppeling invullen

	PANEL PLUS HORIZONTALAAL	PANEL PLUS VRIJSTAAND	SANI RONDA	SANI BASIC	IGUANA	TETRA	DECO SPACE	VERTIGA	PANEL PLUS
SET 34	✓	✓	✓	✓	✓	✓	✓	✓	✓
SET 32	✓	✓	✓	✓	✓	✓	✓	✓	✓

KLEMKOPPELINGEN M24

BESTELVOORBEELD

Bestelcode aansluitset aanvullen met code klemkoppelingen volgens gebruikte buis en Ø. Inbegrepen in de prijs van de aansluitsets.

code aansluitset code klemkoppeling
CODE JF2 AC 1 110

Dunwandig metaal

CODE	BUIS Ø
110	10/1
112	12/1
114	14/1
115	15/1
118	18/1

Kunststof

CODE	BUIS Ø
212	12/2
219	16/1.5
216	16/2
217	17/2
218	18/2

VPE/ALU

CODE	BUIS Ø
314	14/2
316	16/2
326	16/2.2
318	18/2

Stalen c.v. buis

CODE	BUIS Ø
501	M24 x 1/2"
503	M24 x 3/8"

AANSLUITSETS M24

NAAR DE WAND

SET 81



Naar de wand

Tweepijp: Kv 0.28 - 1.15 m³/u bij Δp = 1 bar
KVS 1.15

Éénpijp: Kv 1.10 - 2.10 m³/u bij Δp = 1 bar
KVS 2.10

Thermostaatkop

Verwarmen *

CODE OW2 AC 1...	AC	
CODE OW2 AW 1...	AW	
CODE OW2 AS 1...	AS	
CODE OW2 AB 1...	AB	

Code klemkoppeling invullen

SET 82



Naar de vloer

Tweepijp: Kv 0.28 - 1.15 m³/u bij Δp = 1 bar
KVS 1.15

Éénpijp: Kv 1.10 - 2.10 m³/u bij Δp = 1 bar
KVS 2.10

Thermostaatkop

Verwarmen *

CODE OF2 AC 1...	AC	
CODE OF2 AW 1...	AW	
CODE OF2 AS 1...	AS	
CODE OF2 AB 1...	AB	

Code klemkoppeling invullen

SANI RONDA

SANI BASIC

✓
✓
✓
✓

✓
✓
✓
✓

✓
✓
✓
✓

✓
✓
✓
✓

KLEMKOPPELINGEN M24

BESTELVOORBEELD

Bestelcode aansluitset aanvullen met code klemkoppelingen volgens gebruikte buis en Ø. Inbegrepen in de prijs van de aansluitsets.

code aansluitset code klemkoppeling
CODE JH2 AC 1 110

Dunwandig metaal

CODE	BUIS Ø
110	10/1
112	12/1
114	14/1
115	15/1
118	18/1

Kunststof

CODE	BUIS Ø
212	12/2
219	16/1.5
216	16/2
217	17/2
218	18/2

VPE/ALU

CODE	BUIS Ø
314	14/2
316	16/2
326	16/2.2
318	18/2

Stalen c.v. buis

CODE	BUIS Ø
501	M24 x 1/2"
503	M24 x 3/8"

jaga

CLIMATE
DESIGNERS

LOSSE VENTIELEN





JAGA H-VENTIEL 3/4" EUROCONUS

- aansluiting 3/4" Euroconus buitendraad
- eenpijp en tweepijp
- voorinstelling in 6 stappen
- twee geïntegreerde afsluiters en afsluitbare by-pass
- met schroefdraad M30 x 1,5 (Heimeier compatibel)
- kunststof spindelbescherming voor regeling tijdens de bouwperiode
- niet geschikt voor Strada type 06, Knockonwood type 06 aansluiting naar de wand

Standaard Kv-waarde tweepijp: 0.10 tot 0.60 m³/u

Verkleinde Kv-waarde tweepijp: 0.045 tot 0.32 m³/u

éénpijp: 25% tot 100%

INREGELING VAN HET H-BLOK (TWEEDIJF - EENDIJF): ZIE PAG. XXX

NAAR DE WAND - RECHT

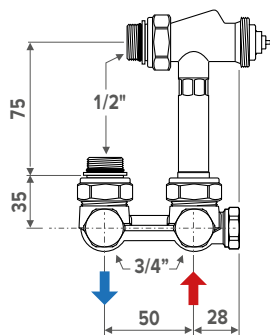

CODE

5094 524	Standaard Kv
5094 544	Kleine Kv

NAAR DE WAND - HAAKS

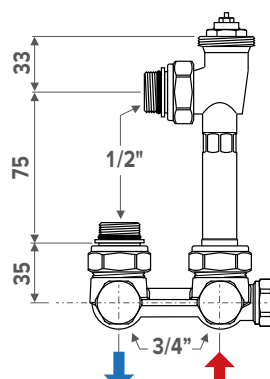

CODE

5094 534	Standaard Kv
5094 554	Kleine Kv

Het Jaga haaks ventiel is alleen geschikt voor gebruik met voeler of thermostaatkop op afstand, of centraal gestuurde regeling (handbediende kop).

NAAR DE VLOER - RECHT

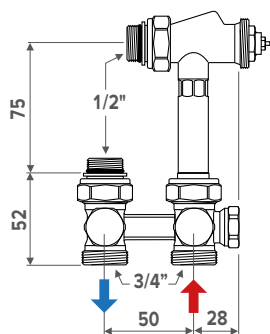

CODE

5094 525	Standaard Kv
5094 545	Kleine Kv

NAAR DE VLOER - HAAKS

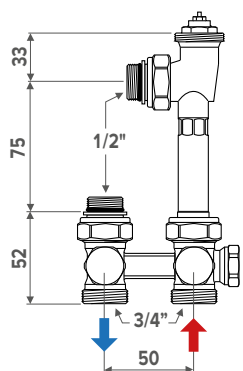

CODE

5094 535	Standaard Kv
5094 555	Kleine Kv

Het Jaga haaks ventiel is alleen geschikt voor gebruik met voeler of thermostaatkop op afstand, of centraal gestuurde regeling (handbediende kop).

SET 103

✓

•

•

•

•

•

•

•

•

•

•

•

•

•

•

•

•

•

•

•

•

•

•

•

•

•

•

•

•

•

•

•

•

•

•

•

•

•

•

•

•

•

•

•

•

JAGA CROSSFLOW VENTIEL 3/4" EUROCONUS

- aansluiting 3/4" Euroconus buitendraad
- tweepijp
- voorinstelling in 6 stappen
- aanvoer en retour volledig afsluitbaar
- met schroefdraad M30 x 1.5 (Heimeier compatibel)
- kunststof spindelbescherming voor regeling tijdens de bouwperiode
- niet geschikt voor Strada type 06, Knockonwood type 06 aansluiting naar de wand

Standaard Kv-waarde: 0.10 tot 0.60 m³/u
 Verkleinde Kv-waarde: 0.045 tot 0.32 m³/u

NAAR DE WAND - RECHT

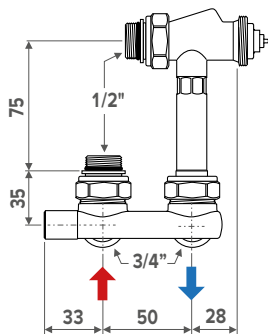

CODE

5094 522	Standaard Kv
5094 542	Kleine Kv

NAAR DE WAND - HAAKS

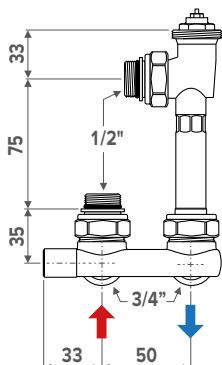

CODE

5094 532	Standaard Kv
5094 552	Kleine Kv

Het Jaga haaks ventiel is alleen geschikt voor gebruik met voeler of thermostaatkop op afstand, of centraal gestuurde regeling (handbediende kop).

NAAR DE VLOER - RECHT

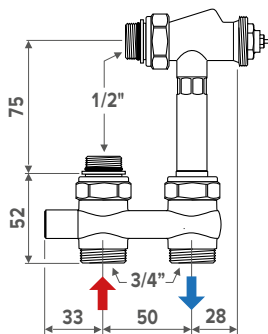

CODE

5094 523	Standaard Kv
5094 543	Kleine Kv

NAAR DE VLOER - HAAKS

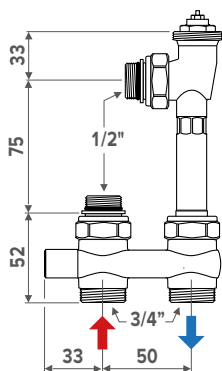

CODE

5094 533	Standaard Kv
5094 553	Kleine Kv

Het Jaga haaks ventiel is alleen geschikt voor gebruik met voeler of thermostaatkop op afstand, of centraal gestuurde regeling (handbediende kop).

SET 101
 SET 102
 SET 111
 SET 112
 SET 115
 SET 116

✓	-	-	-	-	-	-
-	-	✓	-	✓	-	-
-	✓	-	-	-	-	-
-	-	-	-	-	-	-

JAGA VENTIEL 3/4" EUROCONUS

- speciaal verkort thermostaatventiel volledig verborgen binnen de bekleding
- aansluiting 3/4" Euroconus buitendraad
- tweepijp
- voorinstelling in 6 stappen
- met schroefdraad M30 x 1.5 (Heimeier compatibel)
- kunststof spindelbescherming voor regeling tijdens de bouwperiode

Standaard Kv-waarde: 0.10 tot 0.60 m³/u

Verkleinde Kv-waarde: 0.045 tot 0.32 m³/u (herkenning: rode spindelbescherming)

NAAR DE WAND OF DE VLOER

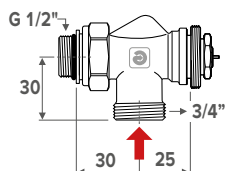

CODE

5090 4407	Standaard Kv
5090 4406	Kleine Kv

JAGA GAMPPER VARIO DP DYNAMISCH VENTIEL 3/4" EUROCONUS

- geïntegreerde automatische debietregeling onafhankelijk van het drukverschil
- eenvoudige en snelle instelling van het ontwerpdebiet, zonder ingewikkelde berekeningen
- traploze voorinstelling tussen 1 (10 l/u) en 34 (340 l/u)
- speciaal verkort thermostaatventiel volledig verborgen binnen de bekleding
- aansluiting 3/4" Euroconus buitendraad
- tweepijp
- 100 % afsluitbaar
- schroefdraad M30 x 1.5
- met Keymark certificaat
- getest conform EN 215
- kunststof spindelbescherming voor regeling tijdens de bouwperiode

NAAR DE WAND OF DE VLOER

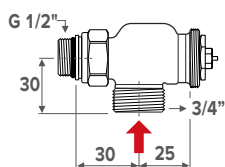

CODE

5090 3407



INSTELLINGEN

	1	1.5	2	2.25	2.5	2.75	3	3.25	3.5	3.75	4	4.25	4.5	4.75
l/u	20	25	35	40	45	55	65	80	90	100	115	135	145	160
P-BAND (K)	1	1	1	1	1	2	2	2	2	2	2	1	2	2

	5	5.25	5.5	5.75	6	6.25	6.5	6.75	7	7.25	7.5	7.75	8
l/u	170	185	200	215	230	245	260	275	290	300	315	330	340
P-BAND (K)	3	3	3	3	3	3	3	3	3	3	3	3	3

SET 222
SET 225
SET 271
SET 272
SET 295
SET 285
SET 282

✓	✓	✓	✓	✓	✓	✓
---	---	---	---	---	---	---

-	-	-	-	-	✓	✓
---	---	---	---	---	---	---

JAGA VENTIEL 3/4" EUROCONUS RECHT

- aansluiting 3/4" Euroconus buitendraad
- tweepijp
- voorinstelling in 6 stappen
- met schroefdraad M30 x 1.5 (Heimeier compatibel)
- kunststof spindelbescherming voor regeling tijdens de bouwperiode

Standaard Kv-waarde: 0.10 tot 0.60 m³/u

RECHT

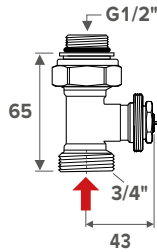

CODE

5094 4430

JAGA RETOURVENTIELEN 3/4" EUROCONUS

HAAKS

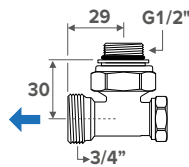

CODE

5090 4111

RECHT

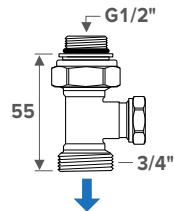

CODE

5094 4431

	SET 222	SET 225	SET 226	SET 262	SET 265	SET 271	SET 272	SET 290	SET 291	SET 294	SET 295
RECHT 5094 4430	-	-	-	-	-	-	-	-	-	✓	-
HAAKS 5090 4111	-	✓	✓	-	✓	-	✓	-	-	-	-
RECHT 5094 4431	✓	-	-	✓	-	✓	-	✓	✓	✓	✓

H-BLOK MET PUNTSTUK 3/4" EUROCONUS

- H-onderblok
- straightflow
- aansluiting naar radiator G1/2 M
- aansluiting voor buis G3/4 M Euroconus
- hartafstand 50mm
- voor 1 pijp en 2 pijp
- KV 1 m³/h bij delta p 1bar

NAAR DE WAND

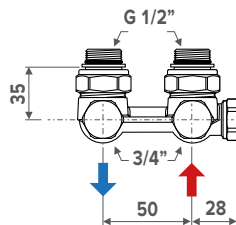

CODE
5094 562

NAAR DE VLOER

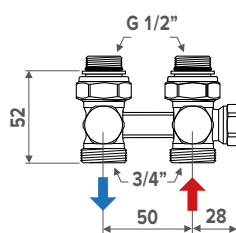

CODE
5094 563

inregeling

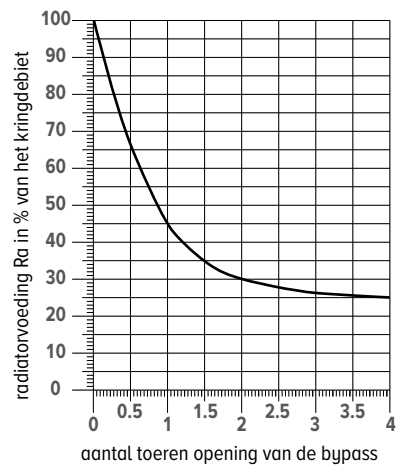
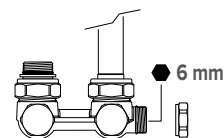

CROSSFLOW BLOK MET PUNTSTUK 3/4" EUROCONUS

- onderblok
- crossflow
- aansluiting naar radiator G1/2 M
- aansluiting voor buis G3/4 M Euroconus
- hartafstand 50mm
- voor 2 pijp
- KV 1 m³/h bij delta p 1bar

NAAR DE WAND

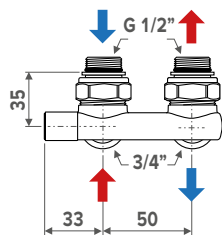

CODE
5094 564

NAAR DE VLOER

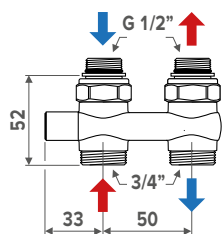

CODE
5094 565

VERLENGPIJP 1/2" BINNENDRAAD

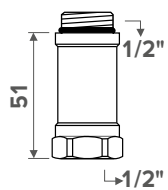

CODE

5090 108

• SET 222

✓ SET 225

✓ SET 226

• SET 262

✓ SET 265

• SET 271

✓ SET 272

JAGA RETOURVENTIELEN 1/2" BINNENDRAAD

RECHT

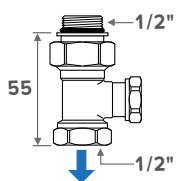

CODE

5090 109

SET 98

SET 99

SET 297

SET 298

SET 299

HAAKS

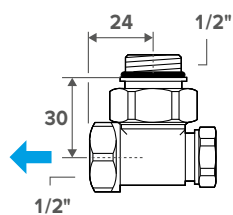

CODE

5090 110

•

✓

•

•

✓

VERLENGDE ONTLUCHTER 1/8"



Standaard meegeleverd bij

- Strada
- Knockonwood
- toestellen met een Twin warmtewisselaar

Optioneel toepasbaar bij

- standaard warmtewisselaar type 10/15/20

Niet mogelijk bij

- Mini
- Play

CODE		
50900 114078	Linea Plus	020
50900 114178		035
50900 114378		050
50900 114528		065
50900 114728		090
50900 114078	Tempo	020
50900 114178	Wandinbouw	030
50900 114278		040
50900 114378		050
50900 114378		060
50900 114528		070
50900 114728		090

RVS AANSLUITFLEXIBELS 1/2"



Optioneel toepasbaar bij

- Briza XS Net Zero
- Briza S Net Zero

CODE		
7990 068	200 < 260 mm	2 stuks

JAGA VENTIEL DN 20

- tweepijp
- met schroefdraad M30 x 1.5 (Heimeier compatibel)
- kunststof spindelbescherming voor regeling tijdens de bouwperiode
- voor warmtewisselaar met 3/4" binnendraad (Briza 22)
- aansluiting 3/4" binnendraad

HAAKS

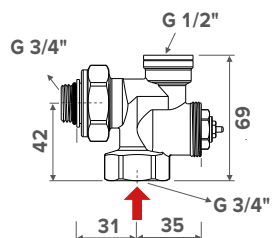

CODE

5090 701

Kv-waarde: 3.4 m³/u bij Δp = 1 bar

RECHT

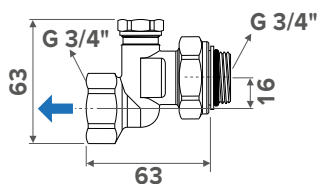

CODE

5090 702

Kv-waarde: 2.5 m³/u bij Δp = 1 bar

SET 301

✓

SET 302

•

JAGA VENTIEL DN 20

- tweepijp
- met schroefdraad M30 x 1.5 (Heimeier compatibel)
- kunststof spindelbescherming voor regeling tijdens de bouwperiode
- voor warmtewisselaar met 1/2" binnendraad
- aansluiting 3/4" binnendraad

HAAKS

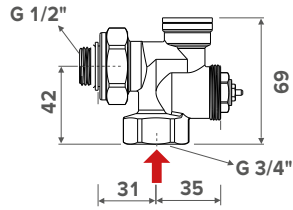

CODE

5090 703

Kv-waarde: 3.4 m³/u bij Δp = 1 bar

HAAKS

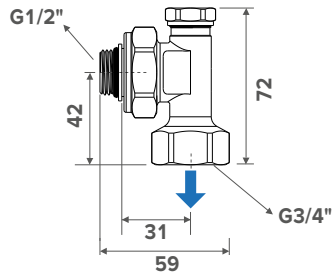

CODE

5090 704

Kv-waarde: 0.8 m³/u bij Δp = 1 bar

SET 303

SET 304

✓

·

✓

✓

JAGA PRO VENTIEL M24 X 1.5 BUITENDRAAD

- aansluiting M24 buitendraad
- eenpijp en tweepijp
- voorinstelling in 6 stappen
- aanvoer en retour volledig afsluitbaar
- met schroefdraad M30 x 1,5 (Heimeier compatibel)
- kunststof spindelbescherming voor regeling tijdens de bouwperiode

KV-WAARDE:

- tweepijp:
 - Standaard Kv-waarde: 0.03 tot 0.60 m³/u
 - Verkleinde Kv-waarde: 0.045 tot 0.2 m³/u (*herkenning: rode spindelbescherming*)
- éénpijp: 50% tot 0%



JAGA PRO

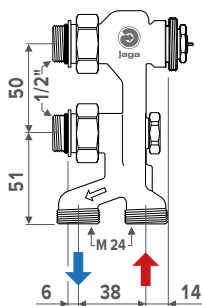

CODE

5094 4414	Tweepijp
5094 4409	Éénpijp
5094 413	Tweepijp - kleine Kv

BOCHT 90° M24 X M24

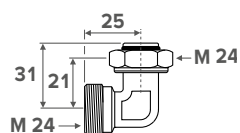

CODE

5095 020

OMKEERSTUK MET AFSLUITERS VOOR JAGA PRO VENTIELEN

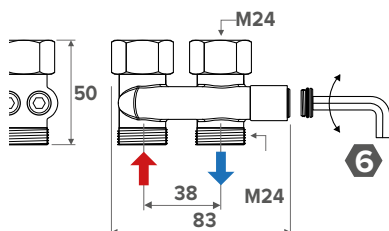

CODE

5094 520

Hulpstuk bij renovatie, voor omwisseling van aanvoer en retour bij alle Jaga Pro ventielen. Gebruik klemkoppelingen M24.

	SET 11	SET 12	SET 13	SET 14
•	•	•	•	•
•	•	•	•	•
•	•	•	•	•
•	•	•	•	•

✓	-	✓	-
---	---	---	---

-	-	-	-
---	---	---	---

JAGA DECO ÉÉNPUNTSAANSLUITING M24 19/'' CHROOM

- voor één- of tweepijp
- thermostaatkop kan links of rechts geplaatst worden
- aanvoer links of rechts, onafhankelijk van positie thermostaatkop
- kunststof spindelbescherming voor regeling tijdens de bouwperiode
- voorinstelbaar

Kv-waarde:

- tweepijp: Kv 0.28 - 1.15 m³/u
- éénpijp: Kv 1.10 - 2.10 m³/u

JAGA DECO HAAKS

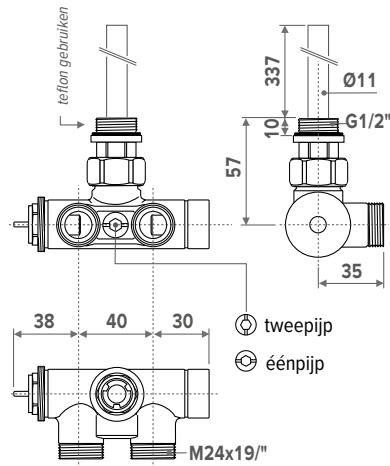

CODE

5094 428

JAGA DECO RECHT

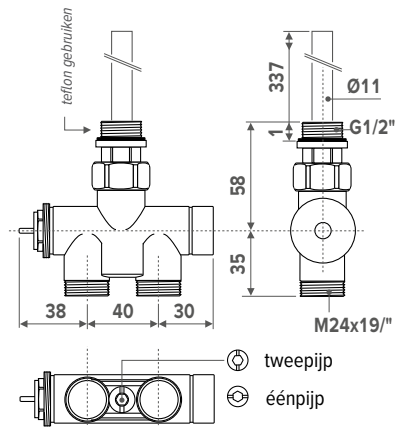

CODE

5094 426

SET 81



SET 82



JAGA DECO PRO VENTIEL M24 19" CHROOM

- geschikt voor alle radiatoren met aansluiting MM, LL of RR
- voor één- of tweepijp
- thermostaatkop kan links of rechts geplaatst worden
- aanvoer links of rechts, onafhankelijk van positie thermostaatkop
- kunststof spindelbescherming voor regeling tijdens de bouwperiode

Kv-waarde:

- tweepijp: Kv 0.29 - 1.65 m³/u
- éénpijp: Kv 1.50 - 2.20 m³/u

JAGA DECO PRO

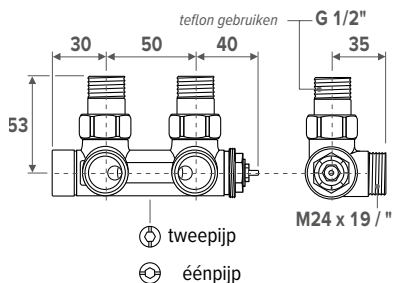

CODE

5094 427	chrom
5094 432	mat aluminium look
5094 433	geborsteld RVS-look

SET 41

✓

SET 42

-

SET 48

✓

SET 49

-

JAGA PRO HAAKS

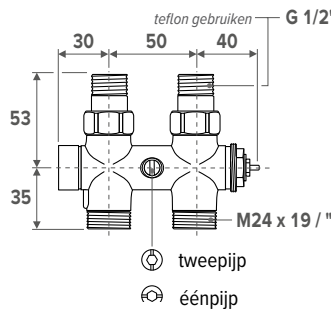

CODE

5094 425	chrom
5094 434	mat aluminium look
5094 435	geborsteld RVS-look

-

✓

-

-

-

-

-

✓

-

-

-

✓

JAGA DECO HAAKS HANDBEDIEND VENTIEL M24 19/'' CHROOM

- inclusief handknop
- handbediend gechromeed ventiel voor aansluiting naar de wand
- knop in 3 kleuren, met gechromeerde schroef

JAGA DECO HAAKS

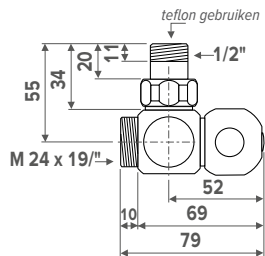

CODE

5096 00201	Chroom
5096 00202	Wit
5096 00203	Zwart

JAGA DECO RECHT

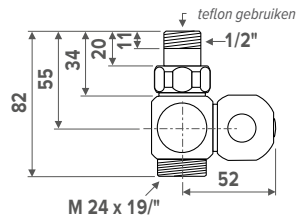

CODE

5096 00101	Chroom
5096 00102	Wit
5096 00103	Zwart

SET 31

✓
✓
✓

SET 32

·
·
·

·
·
·

✓
✓
✓

JAGA DECO VENTIEL M24 19/'' CHROOM

- kunststof spindelbescherming voor regeling tijdens de bouwperiode

Kv-waarde:

- standaard Kv 0.30 - 2.50 m³/u (wit)
- kleine Kv 0.10 - 0.84 m³/u (rood)

JAGA DECO HAAKS

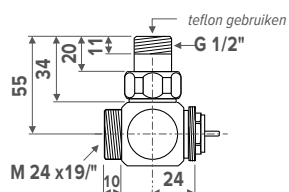

CODE

5094 422	Standaard Kv
5094 5422	Kleine Kv

⚠ *Kleine Kv is niet geschikt voor Iguana

JAGA DECO RECHT

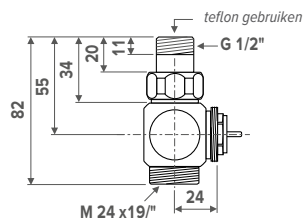

CODE

5094 420	Standaard Kv
5094 5420	Kleine Kv

⚠ *Kleine Kv is niet geschikt voor Iguana

JAGA DECO DUBBEL HAAKS

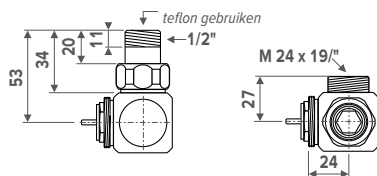

CODE

5094 423	Standaard Kv
----------	--------------

SET 33

✓

SET 34

-

SET 35

-

SET 36

✓

SET 37

-

JAGA DECO RETOURVENTIEL M24 19/'' CHROOM

- geschikt als voorinstelling (zie grafiek drukverlies)

JAGA DECO HAAKS

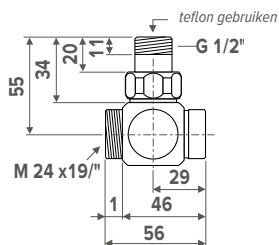

CODE

5096 004

JAGA DECO RECHT

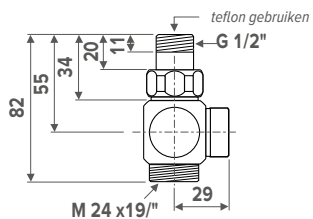

CODE

5096 003

Chroom

JAGA DECO DUBBEL HAAKS

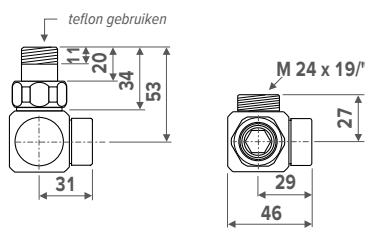

CODE

5096 005

Standaard Kv

	SET 31	SET 32	SET 33	SET 34	SET 34	SET 36	SET 37
5096 004	✓	·	✓	·	·	✓	·
5096 003	·	✓	·	✓	·	·	✓
5096 005	·	·	·	·	✓	·	·

KLEMKOPPELINGEN - NIKKEL

KLEMKOPPELINGEN EUROCONUS

Max. aanhaalmoment:

- dunwandig metaal
 - zacht koper 45-55 Nm
 - halfhard koper 60-80 Nm
 - zacht staal 60-70 Nm
- kunststof 30-40 Nm
- VPE/ALU 20-30 Nm

DUNWANDIG METAAL

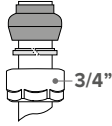

CODE	OMSCHRIJVING
5094 2112	Ø 3/4" x 12/1
5094 2114	Ø 3/4" x 14/1
5094 2115	Ø 3/4" x 15/1
5094 2116	Ø 3/4" x 16/1
5094 2118	Ø 3/4" x 18/1

KUNSTSTOF OF VPE/ALU

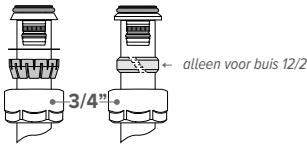

CODE	OMSCHRIJVING
5094 2612	Ø 3/4" x 12/2
5094 2614	Ø 3/4" x 14/2
5094 2616	Ø 3/4" x 16/2
5094 2618	Ø 3/4" x 18/2
5094 2619	Ø 3/4" x 16/1.5
5094 2620	Ø 3/4" x 20/2

KLEMKOPPELINGEN 1/2"

Max. aanhaalmoment:

- dunwandig metaal
 - zacht koper 45-55 Nm
 - halfhard koper 60-80 Nm
 - zacht staal 60-70 Nm
- kunststof 30-40 Nm
- VPE/ALU 20-30 Nm

DUNWANDIG METAAL

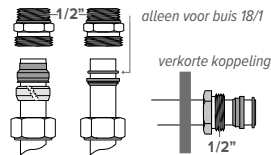

CODE	OMSCHRIJVING
5098 110	Ø 1/2" x 10/1
5098 112	Ø 1/2" x 12/1
5098 114	Ø 1/2" x 14/1
5098 115	Ø 1/2" x 15/1
5098 116	Ø 1/2" x 16/1
5098 118	Ø 1/2" x 18/1

VERKORTE KOPPELING

5098 015	Ø 1/2" x 15/1
----------	---------------

KUNSTSTOF

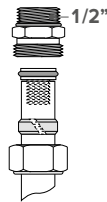

CODE	OMSCHRIJVING
5098 212	Ø 1/2" x 12/2
5098 214	Ø 1/2" x 14/2
5098 219	Ø 1/2" x 16/1.5
5098 216	Ø 1/2" x 16/2
5098 217	Ø 1/2" x 17/2
5098 218	Ø 1/2" x 18/2

VPE/ALU



CODE	OMSCHRIJVING
5098 314	Ø 1/2" x 14/2
5098 316	Ø 1/2" x 16/2
5098 326	Ø 1/2" x 16/2.2
5098 318	Ø 1/2" x 18/2

STALEN C.V. BUIS



CODE	OMSCHRIJVING
5094 502	Ø 1/2" x 1/2"
5094 504	Ø 1/2" x 3/8"

KLEMKOPPELINGEN M24 X 1.5

Max. aanhaalmoment:

- dunwandig metaal
 - zacht koper 45-55 Nm
 - halfhard koper 60-80 Nm
 - zacht staal 60-70 Nm
- kunststof 30-40 Nm
- VPE/ALU 20-30 Nm

DUNWANDIG METAAL

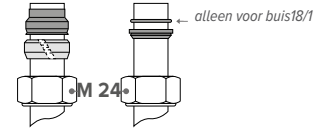

CODE	OMSCHRIJVING
5094 110	Ø M24 x 10/1
5094 112	Ø M24 x 12/1
5094 114	Ø M24 x 14/1
5094 115	Ø M24 x 15/1
5094 116	Ø M24 x 16/1
5094 118	Ø M24 x 18/1

KUNSTSTOF

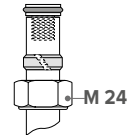

CODE	OMSCHRIJVING
5094 212	Ø M24 x 12/2
5094 214	Ø M24 x 14/2
5094 219	Ø M24 x 16/1.5
5094 216	Ø M24 x 16/2
5094 217	Ø M24 x 17/2
5094 218	Ø M24 x 18/2

VPE/ALU

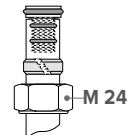

CODE	OMSCHRIJVING
5094 314	Ø M24 x 14/2
5094 316	Ø M24 x 16/2
5094 326	Ø M24 x 16/2.2
5094 318	Ø M24 x 18/2

STALEN C.V. BUIS

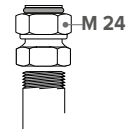

CODE	OMSCHRIJVING
5094 501	Ø M24 x 1/2"
5094 503	Ø M24 x 3/8"

KLEMKOPPELINGEN - CHROOM

KLEMKOPPELINGEN M24 X 19/8"

Max. aanhaalmoment:

- dunwandig metaal
 - zacht koper 45-55 Nm
 - halfhard koper 60-80 Nm
 - zacht staal 60-70 Nm
- kunststof 30-40 Nm
- VPE/ALU 20-30 Nm

DUNWANDIG METAAL

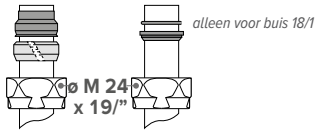

CODE	OMSCHRIJVING
5094 1110	$\varnothing M 24 \times 10/1$
5094 1112	$\varnothing M 24 \times 12/1$
5094 1114	$\varnothing M 24 \times 14/1$
5094 1115	$\varnothing M 24 \times 15/1$
5094 1118	$\varnothing M 24 \times 18/1$

KUNSTSTOF

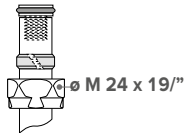

CODE	OMSCHRIJVING
5094 1212	$\varnothing M 24 \times 12/2$
5094 1219	$\varnothing M 24 \times 16/1.5$
5094 1216	$\varnothing M 24 \times 16/2$
5094 1217	$\varnothing M 24 \times 17/2$
5094 1218	$\varnothing M 24 \times 18/2$

VPE/ALU

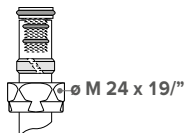

CODE	OMSCHRIJVING
5094 1314	$\varnothing M 24 \times 14/2$
5094 1316	$\varnothing M 24 \times 16/2$
5094 1326	$\varnothing M 24 \times 16/2.2$
5094 1318	$\varnothing M 24 \times 18/2$

STALEN C.V. BUIS

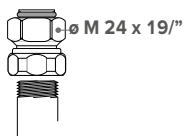

CODE	OMSCHRIJVING
5094 1501	$\varnothing M 24 \times 1/2''$
5094 1504	$\varnothing M 24 \times 3/8''$

THERMOSTAATKOPPEN

JAGA THERMOSTAATKOP



wit RAL 9016



- vloeistofvulling
- vorstbeveiliging 6°C
- min. en max. temperatuurbegrenzing 5-26°C d.m.v. instelringen
- opschroefbaar M30 x 1.5
- max. watertemperatuur 110°C

CODE

5090 1125 Wit RAL 9016

JAGA DECO THERMOSTAATKOP



Jaga chroom



Jaga zilver



Jaga zwart



Jaga wit RAL 9016

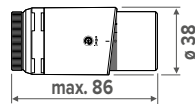

- vloeistofvulling
- vorstbeveiliging 7°C
- regelbereik van 10 tot 28°C
- opschroefbaar M30 x 1.5
- max. watertemperatuur 110°C

CODE

5090 1151 Chroom
5090 1152 Zilver
5090 1153 Zwart
5090 1150 Wit RAL 9016

JAGA HEIMEIER THERMOSTAATKOP VERWARMEN ÉN KOELEN



wit RAL 9016

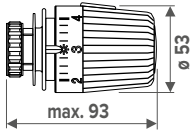

- VT-score: 0.20
- hysteresis EN215: 0 15 K
- invloed van de watertemperatuur EN215: 0 35 K
- vloeistofvulling
- schaalindeling 1 t/m 5 + K.
- vorstbeveiliging 6°C
- min. en max. temperatuurbegrenzing d.m.v. spaarclips
- opschroefbaar M30 x 1.5
- max. element-temperatuur +50°C
- adapter 5090 114 niet van toepassing

CODE

5090 1161 Wit RAL 9016

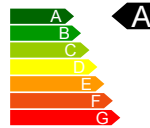

JAGA HEIMEIER THERMOSTAATKOP



wit RAL 9016

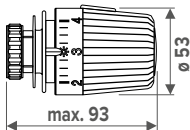

- VT-score: 0.20
- hysteresis EN215: 0 15 K
- invloed van de watertemperatuur EN215: 0 35 K
- vloeistofvulling
- regelbereik van 6 tot 28 °C
- vorstbeveiliging 6°C
- min. en max. temperatuurbegrenzing d.m.v. spaarclips
- opschroefbaar M30 x 1.5
- max. watertemperatuur 120°C
- Light Cooling mogelijk mits gebruik van adapter 5090 114

CODE

5090 1160 Wit RAL 9016

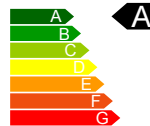

JAGA HANDBEDIENDE KOP



wit RAL 9016

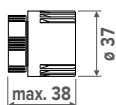

CODE

5090 110103 Wit RAL 9010

THERMOSTAATKOPPEN

THERMO-ELEKTRISCHE MOTOR



licht grijs RAL 7035

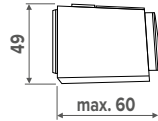

- opschroefbaar M30 x 1.5, met klikbevestiging, geschikt voor alle Jaga ventielen
- met varistor ter bescherming tegen overspanningen
- met standindicator (open/dicht)
- kabellengte: 1 m
- max. watertemperatuur: 100°C
- Isolatieklasse: IP 54 / III
- CE conform EN 60730

CODE

8727 0202	24 VDC
7990 4091	230 VAC



230 VAC: bij vloerinbouw enkel monteren op de verdeler, nooit in de put

JAGA DANFOSS WANDTHERMOSTAAT



wit RAL 9010

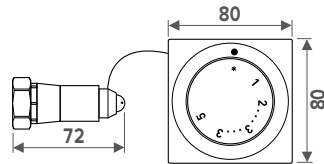

- thermostaatkop met afstandbediening voor moeilijk te bereiken afsluiters
- lengte capillair: 2 m
- doorvoer capillair: min. 23 mm
- afstandsvouler, capillair en bedieningsbalg zijn volledig met vloeistof gevuld
- vorstbeveiliging 7.5°C
- min. en max. T° begrenzing (6-28°C)
- opschroefbaar M30 x 1.5
- max. watertemperatuur 120°
- Light Cooling mogelijk mits gebruik van adapter 5090 114

CODE

5090 1071	Wit RAL 9010
-----------	--------------

JAGA DANFOSS WANDTHERMOSTAAT



wit RAL 9010

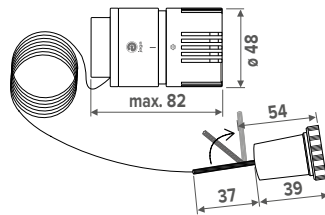

- thermostaatkop met afstandbediening voor moeilijk te bereiken afsluiters
- lengte capillair: 2 m
- minimum binnendiameter buis voor doorvoer capillair: 18 mm
- vloeistofvulling
- vorstbeveiliging 6°C
- regelbereik van 5 tot 26°C
- opschroefbaar M30 x 1.5
- max. watertemperatuur 110°C
- Light Cooling mogelijk mits gebruik van adapter 5090 114

CODE

5090 1107	Wit RAL 9010
-----------	--------------



deze wandthermostaat alleen gebruiken in combinatie met bijgeleverd capillair van 2 meter lengte

DIEFSTALBEVEILIGING



wit RAL 9016

- diefstalbeveiliging voor Jaga thermostaatkoppen
- temperatuurinstelling blijft mogelijk.
- niet toepasbaar bij Strada en Knockonwood in combinatie met Pro ventiel

CODE

5090 1118	Wit RAL 9016
-----------	--------------

JAGA ADAPTER VOOR THERMOSTAATKOPPEN BIJ HYBRIDE INSTALLATIES



adapter voor het ombouwen van thermostaatventielen met thermostaatkop, om te voorkomen dat koudwatertoevoer in de zomer door de thermostaatkop afgesneden wordt

CODE

5090 1114

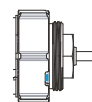
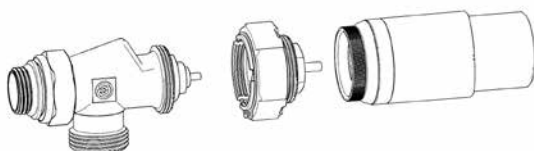

ventiel vergrendeld - open voor koeling

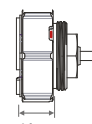

ventiel thermostatisch geregeld met thermostaatkop voor verwarming

16 mm

DRUKVERLIEZEN

TWEEPIJP - STANDAARD KV

VOORINSTELLING	1	2	3	4	5	6	KVS
KV	0.10	0.20	0.30	0.40	0.50	0.60	0.80
2-PIJP	✓	✓	✓	✓	✓	✓	-

**JAGA H-VENTIEL
WAND**
5094.524



Set: 103

**JAGA H - VENTIEL
VLOER**
5094.525



Set: 104

**JAGA H-VENTIEL
HAAKS WAND**
5094.534



Set: 113, 117

**JAGA H-VENTIEL
HAAKS VLOER**
5094.535



Set: 114, 118

**JAGA CROSSFLOW
VENTIEL WAND**
5094.522



Set: 101, 115

**JAGA CROSSFLOW
VENTIEL VLOER**
5094.523



Set: 102

**JAGA CROSSFLOW
HAAKS VENTIEL
WAND**
5094.532



Set: 111

**JAGA CROSSFLOW
HAAKS VENTIEL
VLOER**
5094.533



Set: 112, 116

**JAGA VENTIEL
3/4" EUROCONUS**
5090.4407



Set: 222, 225, 271, 272

**JAGA VENTIEL
1/2" BINNENDRAAD**
5090.405



**JAGA DUBBEL
HAAKS VENTIEL**



Set: 28, 29

**JAGA VENTIEL
M24**



Set: 25

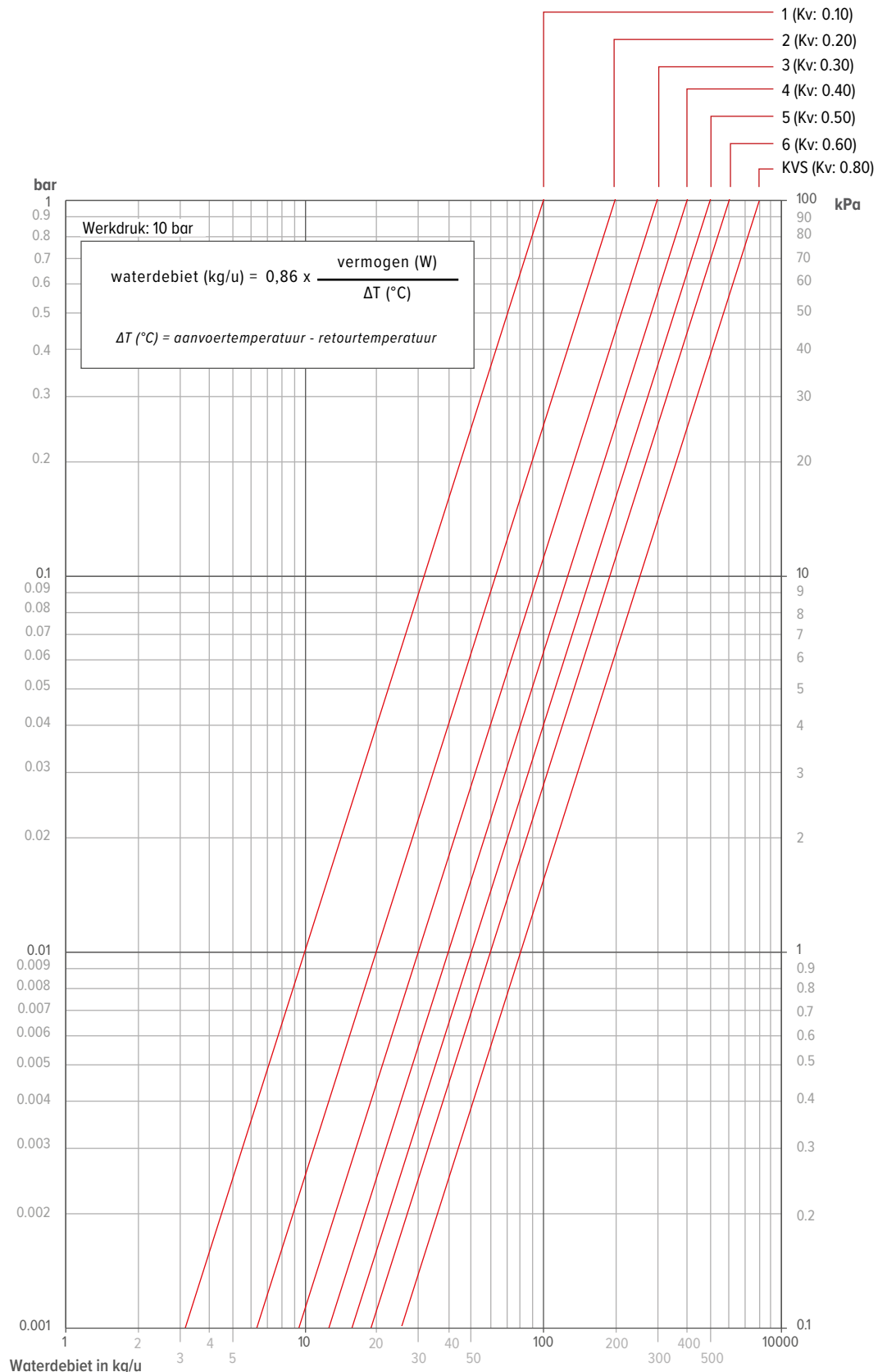

DRUKVERLIEZEN

TWEEPIJP - KLEINE KV

VOORINSTELLING	1	2	3	4	5	6	KVS
KV	0.045	0.065	0.095	0.155	0.220	0.320	0.350
2-PIJP	✓	✓	✓	✓	✓	✓	-

**JAGA H-VENTIEL
WAND**
5094.544



**JAGA H - VENTIEL
VLOER**
5094.545



**JAGA H-VENTIEL
HAAKS WAND**
5094.554



**JAGA H-VENTIEL
HAAKS VLOER**
5094.555



**JAGA CROSSFLOW
VENTIEL WAND**
5094.542



**JAGA CROSSFLOW
VENTIEL VLOER**
5094.543



**JAGA CROSSFLOW
HAAKS VENTIEL WAND**
5094.552



**JAGA CROSSFLOW
HAAKS VENTIEL VLOER**
5094.553



**JAGA VENTIEL
3/4" EUROCONUS**
5090.4406



**JAGA VENTIEL
1/2" BINNENDRAAD**
5090.404



**JAGA PRO VENTIEL
M24 BUITENDRAAD**
5094.413

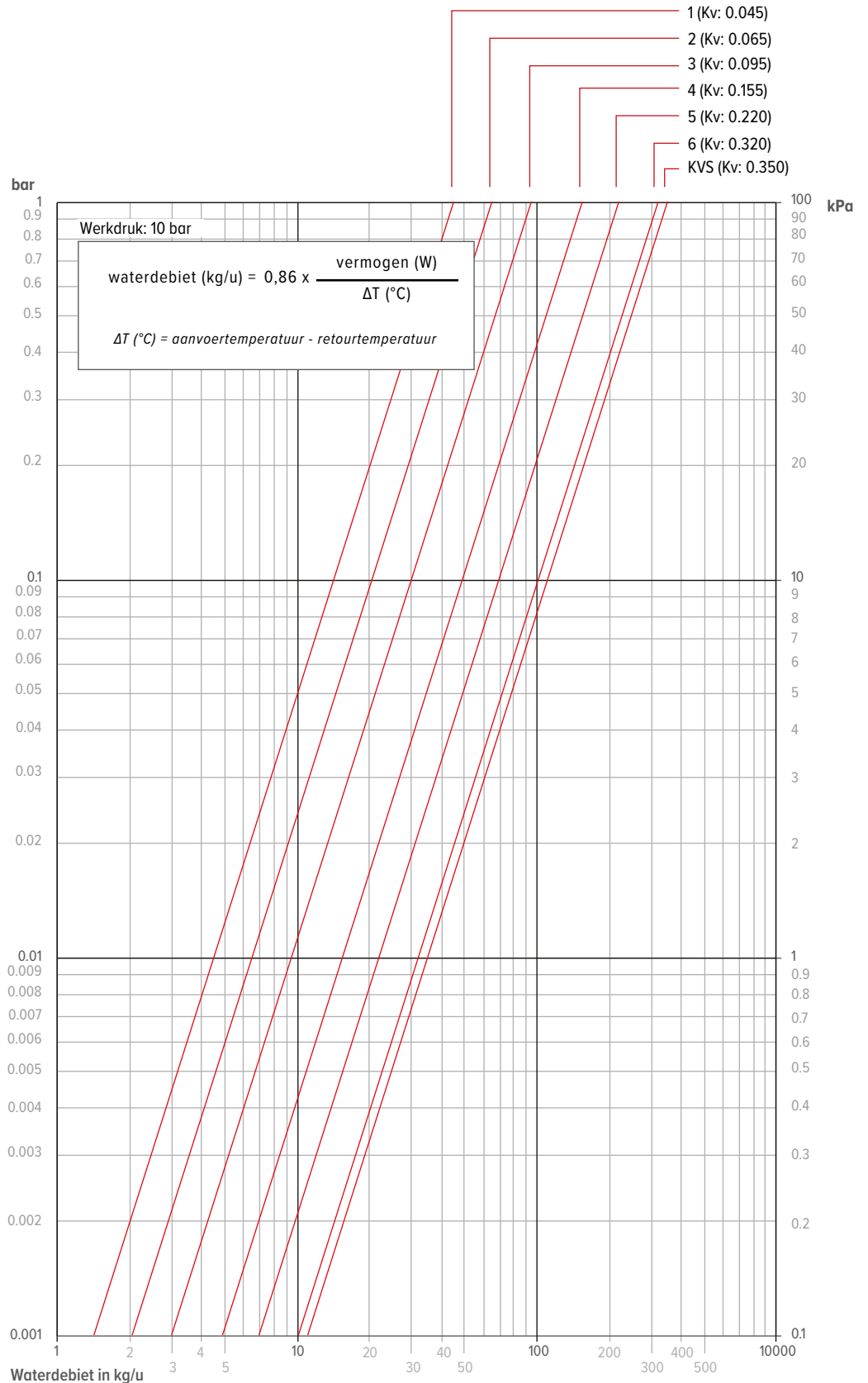

DRUKVERLIEZEN

TWEEPIJP

VOORINSTELLING	1	2	3	4	5	6	KVS
KV	0.07	0.16	0.32	0.44	0.51	0.60	0.80

JAGA PRO VENTIEL
M24 BUITENDRAAD

5094.4414



Set 11, 12

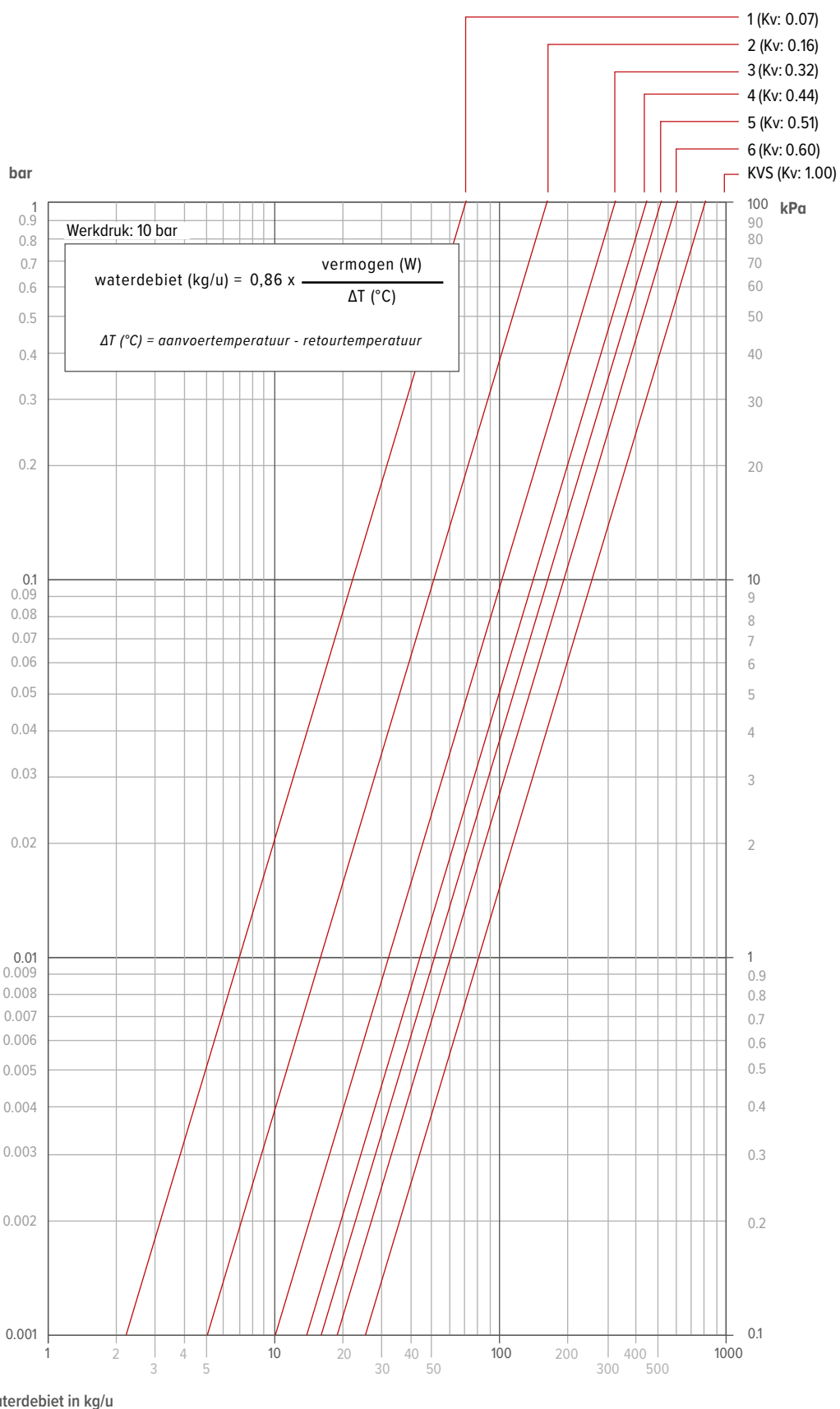

DRUKVERLIEZEN

ÉÉNPIJP

VOORINSTELLING	1	2	3	4	5	6	7	8	KVS
RADIATORVOEDING %	0	13.4	17.3	21.9	27.4	31.3	32.8	35.1	50.0
KV	1.34	1.55	1.62	1.72	1.85	1.95	2.00	2.06	2.68

JAGA PRO VENTIEL M24 BUITENDRAAD

5094.4414



Set 13, 14

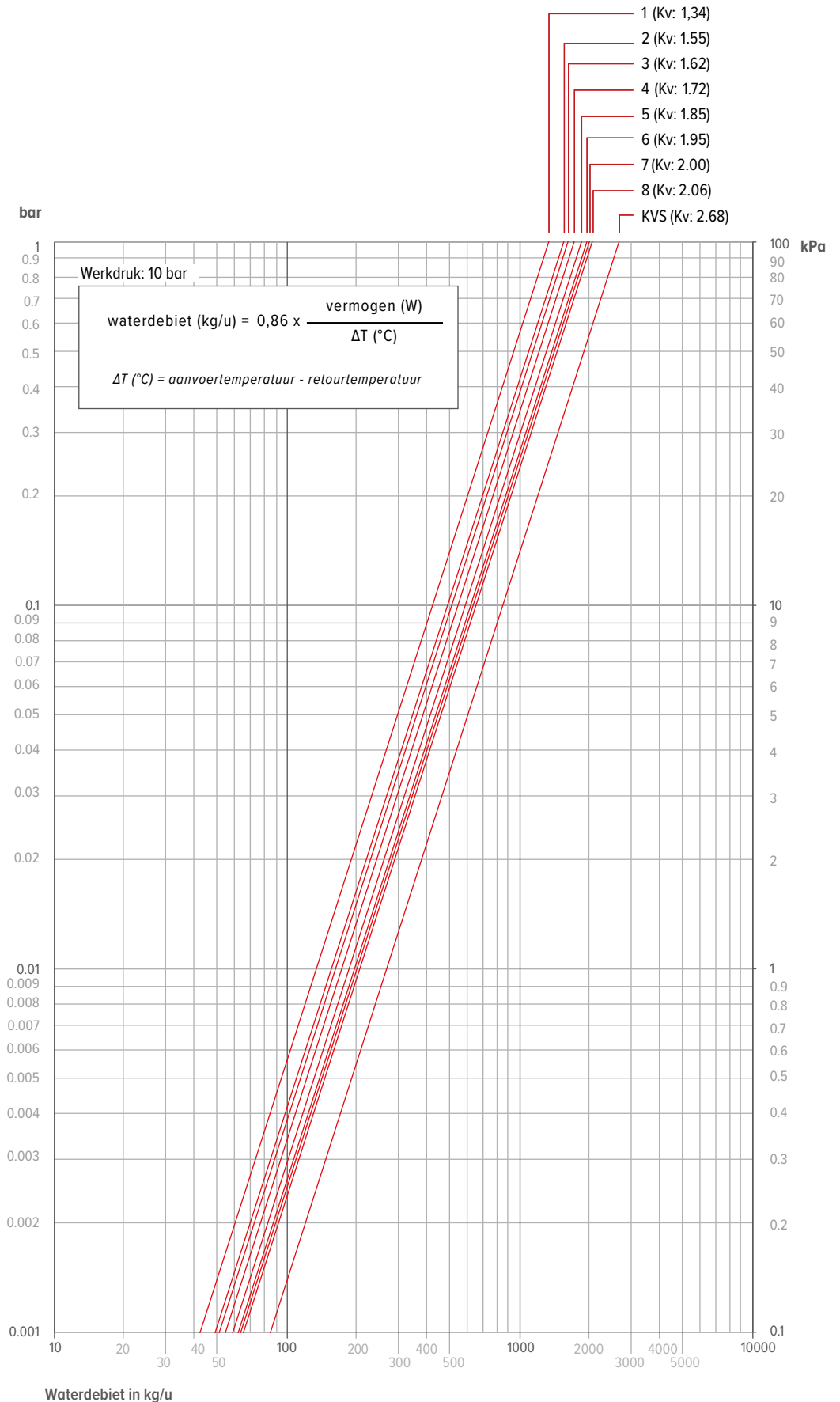

DRUKVERLIEZEN

AANTAL OMWENTELINGEN	2	3	4	open
KV	0.8	1.5	2.1	2.5

JAGA RETOURVENTIELEN
3/4" EUROCONUS RECHT
5090 702



Set 301, 302

JAGA RETOURVENTIELEN
3/4" EUROCONUS HAAKS
5090 704



Set 303, 304

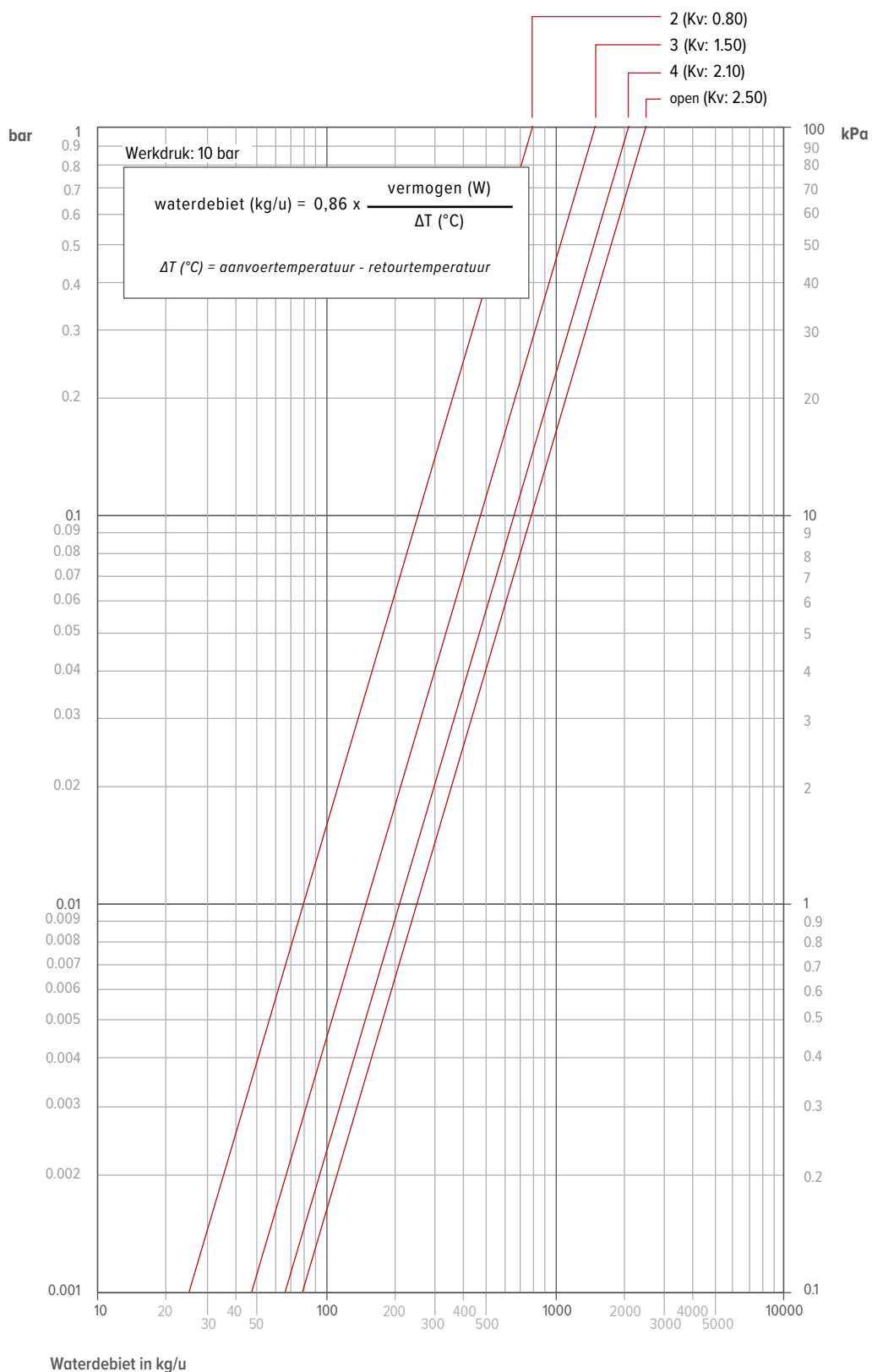

DRUKVERLIEZEN

KV

3.4

JAGA VENTIEL 3/4"
EUROCONUS DN 20 HAAKS
5090 701



Set 301

JAGA VENTIEL 1/2"
BINNENDRAAD HAAKS
5090 702



Set 303

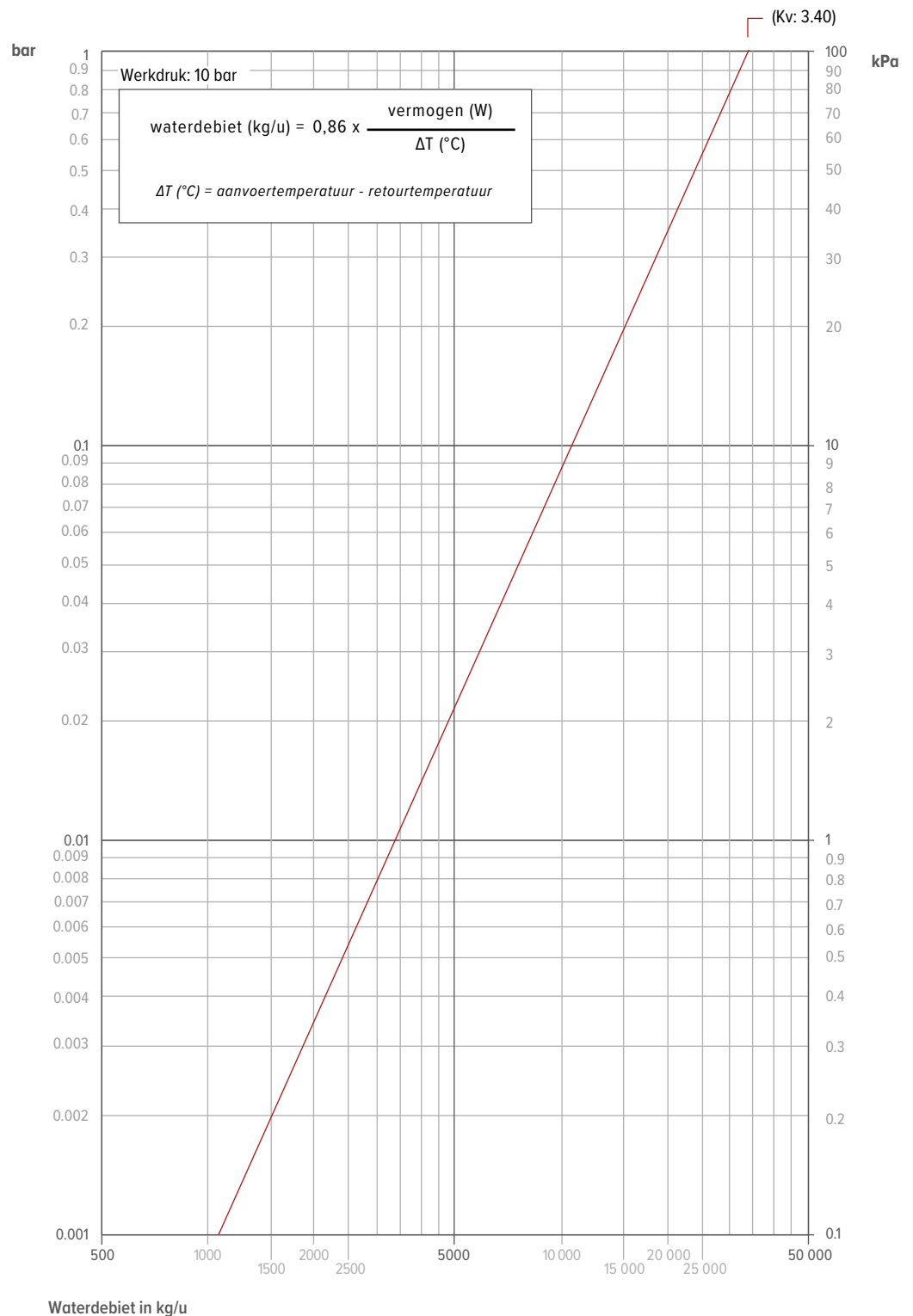

DRUKVERLIEZEN

VOORINSTELLING	1	2	3	4	5	6	7	8	9
AANTAL OMWENTELINGEN	1.25	1.50	1.75	2.00	2.50	3.00	3.50	4.00	open
KV	0.14	0.20	0.31	0.43	0.60	0.79	1.00	1.20	1.35

JAGA RETOURVENTIELEN 3/4" EUROCONUS HAAKS

5090 4111



Set: 225, 226, 265, 272, 285

JAGA RETOURVENTIELEN 3/4" EUROCONUS RECHT

5094 4431



Set: 222, 262, 271, 282

JAGA RETOURVENTIELEN 1/2" BINNENDRAAD RECHT

5090 109



Set: 98, 99, 297, 298, 299

JAGA RETOURVENTIELEN 1/2" BINNENDRAAD HAAKS

5090 110



Set: 99, 299

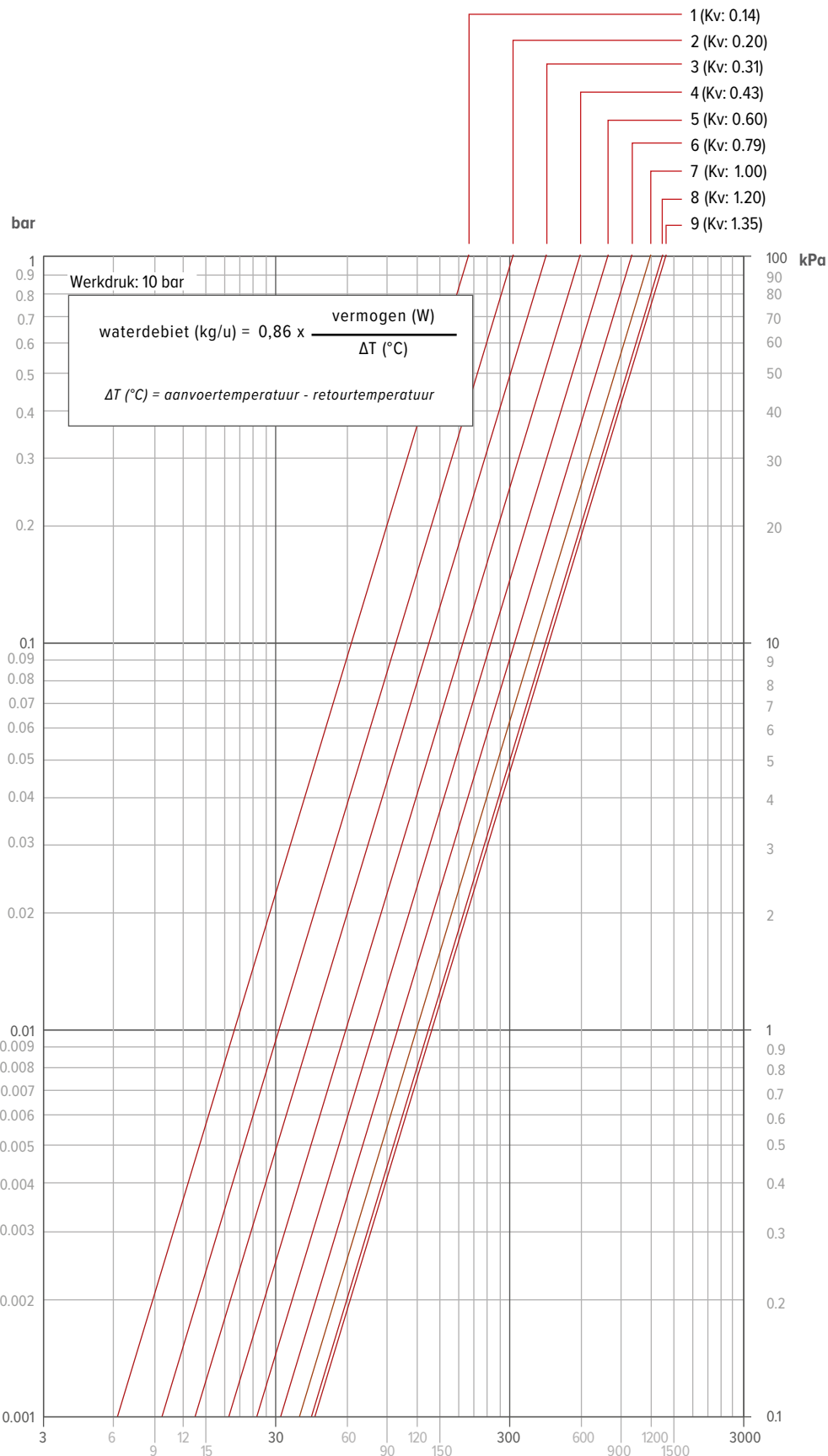

Waterdebiet in kg/u

DRUKVERLIEZEN

ÉÉNPIJP

VOORINSTELLING	0	1	2	3	4	5	6	7
RADIATORVOEDING %	0	11	21	26	29	31	32	32
KV	1.50	1.68	1.90	2.04	2.12	2.17	2.20	2.20

DECO PRO THERMOSTAATVENTIEL HAAKS

- 5094.427 chroom
- 5094.432 mat aluminium look
- 5094.433 geborsteld RVS-look



DECO PRO THERMOSTAATVENTIEL RECHT

- 5094.427 chroom
- 5094.432 mat aluminium look
- 5094.433 geborsteld RVS-look

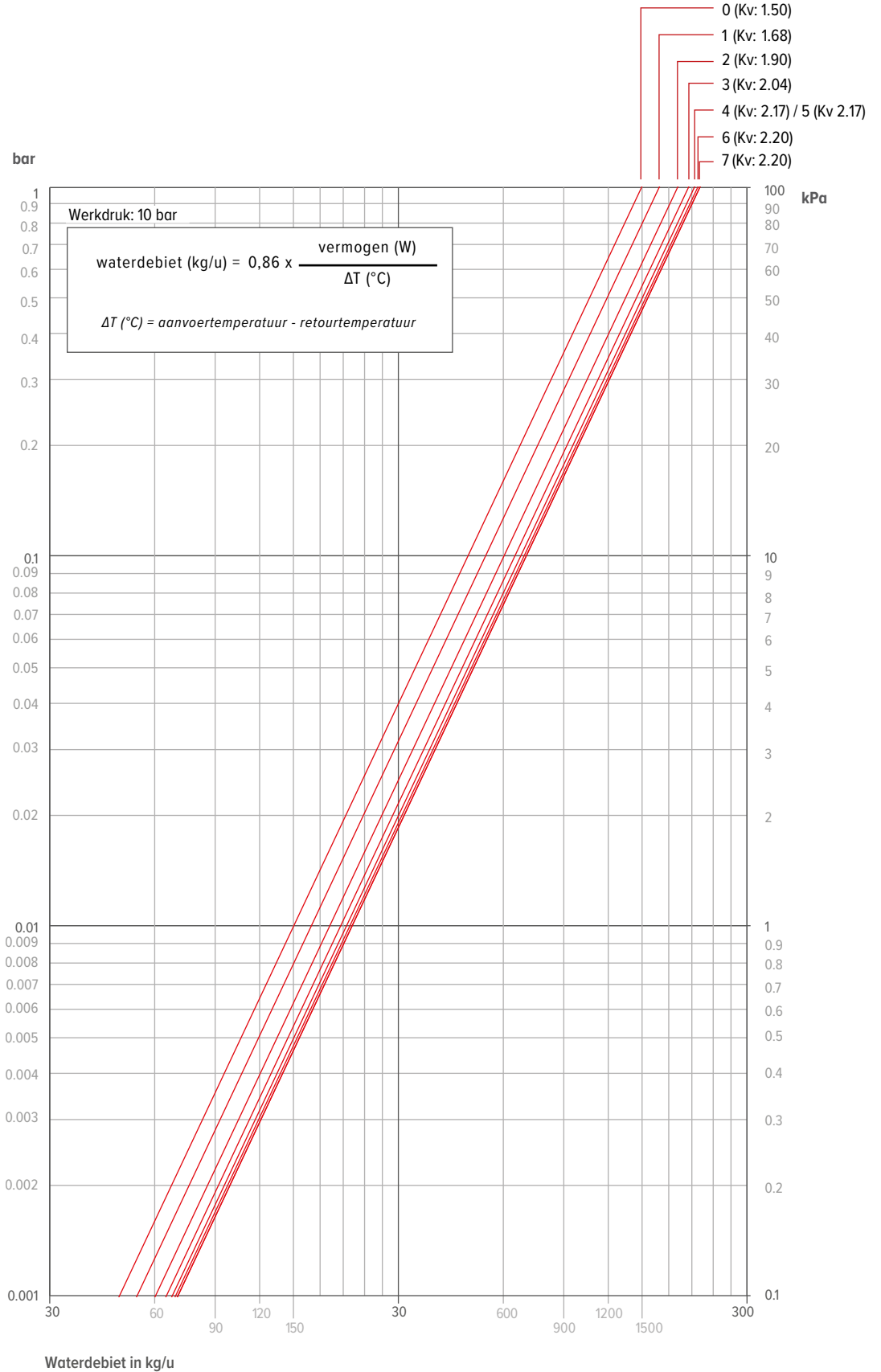

DRUKVERLIEZEN

TWEEPIJP

VOORINSTELLING	0	1	2	3	4	5	6	7	max.
RADIATORVOEDING %	0	100	100	100	100	100	100	100	100
KV	0	0.29	0.72	1.10	1.29	1.46	1.56	1.61	1.65

DECO PRO THERMOSTAATVENTIEL HAAKS

- 5094.427 chroom
- 5094.432 mat aluminium look
- 5094.433 geborsteld RVS-look



DECO PRO THERMOSTAATVENTIEL RECHT

- 5094.427 chroom
- 5094.432 mat aluminium look
- 5094.433 geborsteld RVS-look

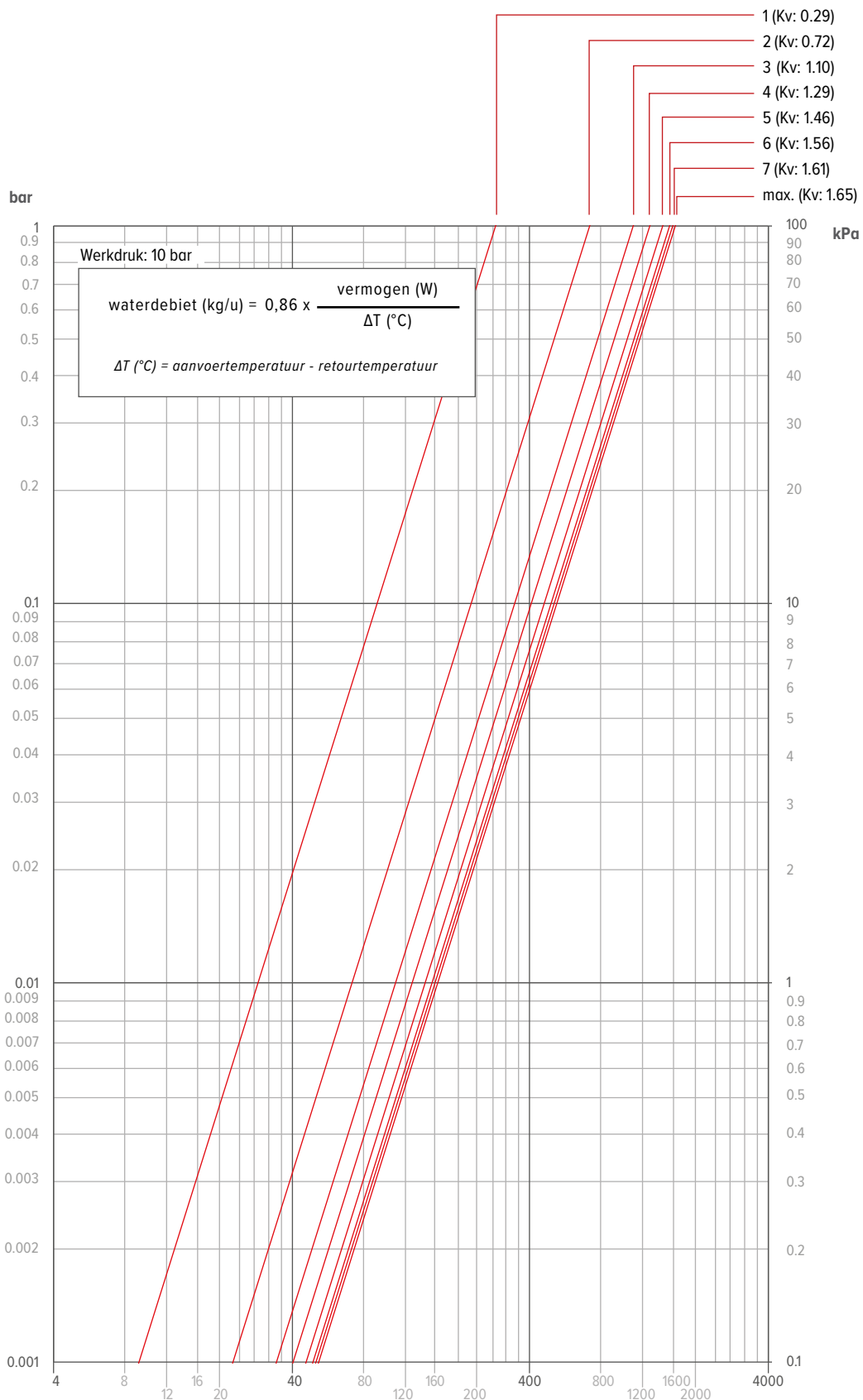

Waterdebiet in kg/u

DRUKVERLIEZEN

STANDAARD KV

VOORINSTELLING	0	1	2	3	4	5	6	7	max.
RADIATORVOEDING %	0	100	100	100	100	100	100	100	100
KV	0	0.30	0.70	1.03	1.31	1.56	1.76	1.90	2.50

JAGA DECO THERMOSTAATVENTIEL HAAKS

5094.422 chroom



JAGA DECO THERMOSTAATVENTIEL DUBBEL HAAKS

5094.422 chroom

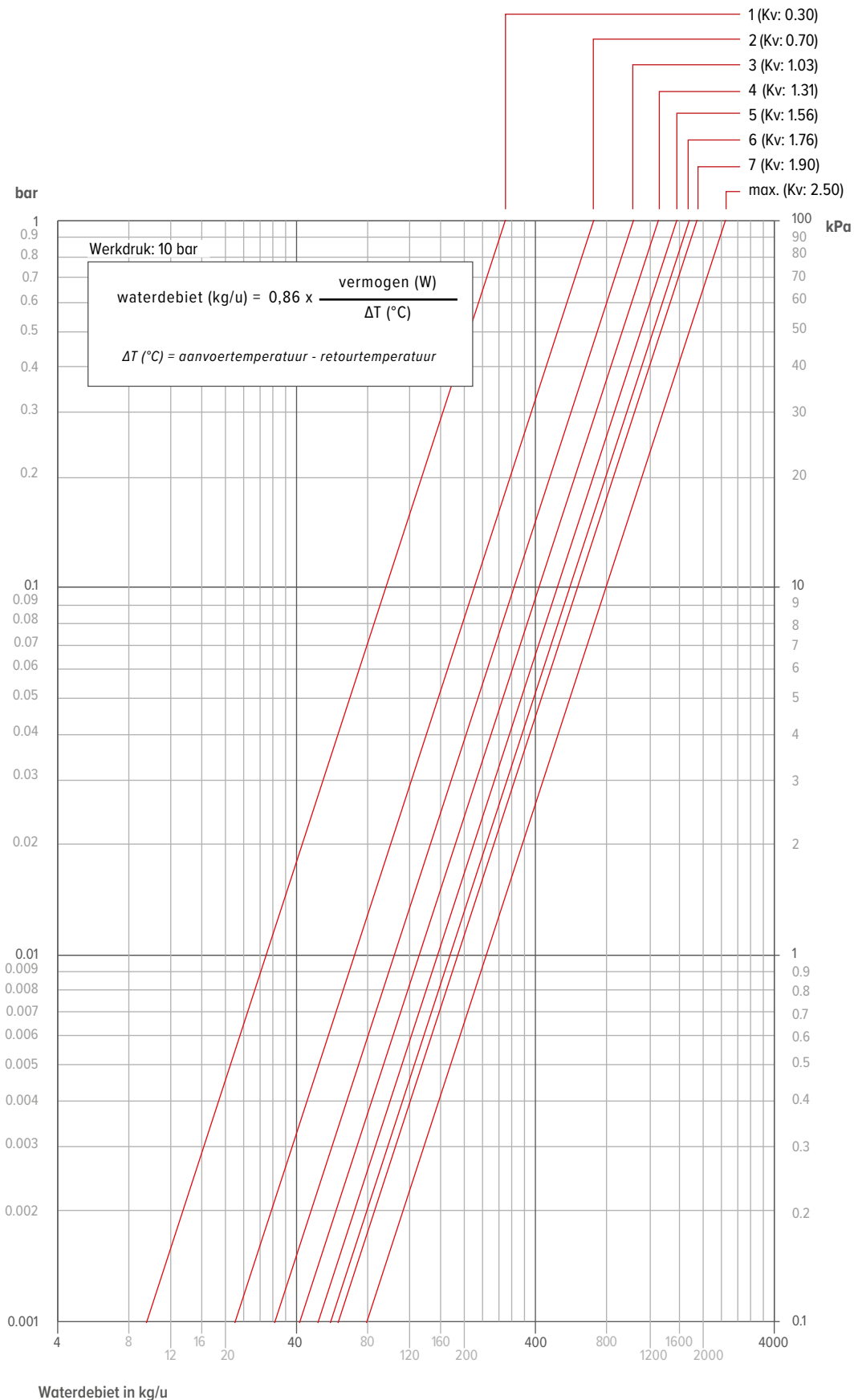

DRUKVERLIEZEN

STANDAARD KV

VOORINSTELLING	0	1	2	3	4	5	6	7	max.
RADIATORVOEDING %	0	100	100	100	100	100	100	100	100
KV	0	0.30	0.73	1.07	1.30	1.45	1.54	1.60	1.85

JAGA DECO THERMOSTAATVENTIEL RECHT

5094.420 chroom

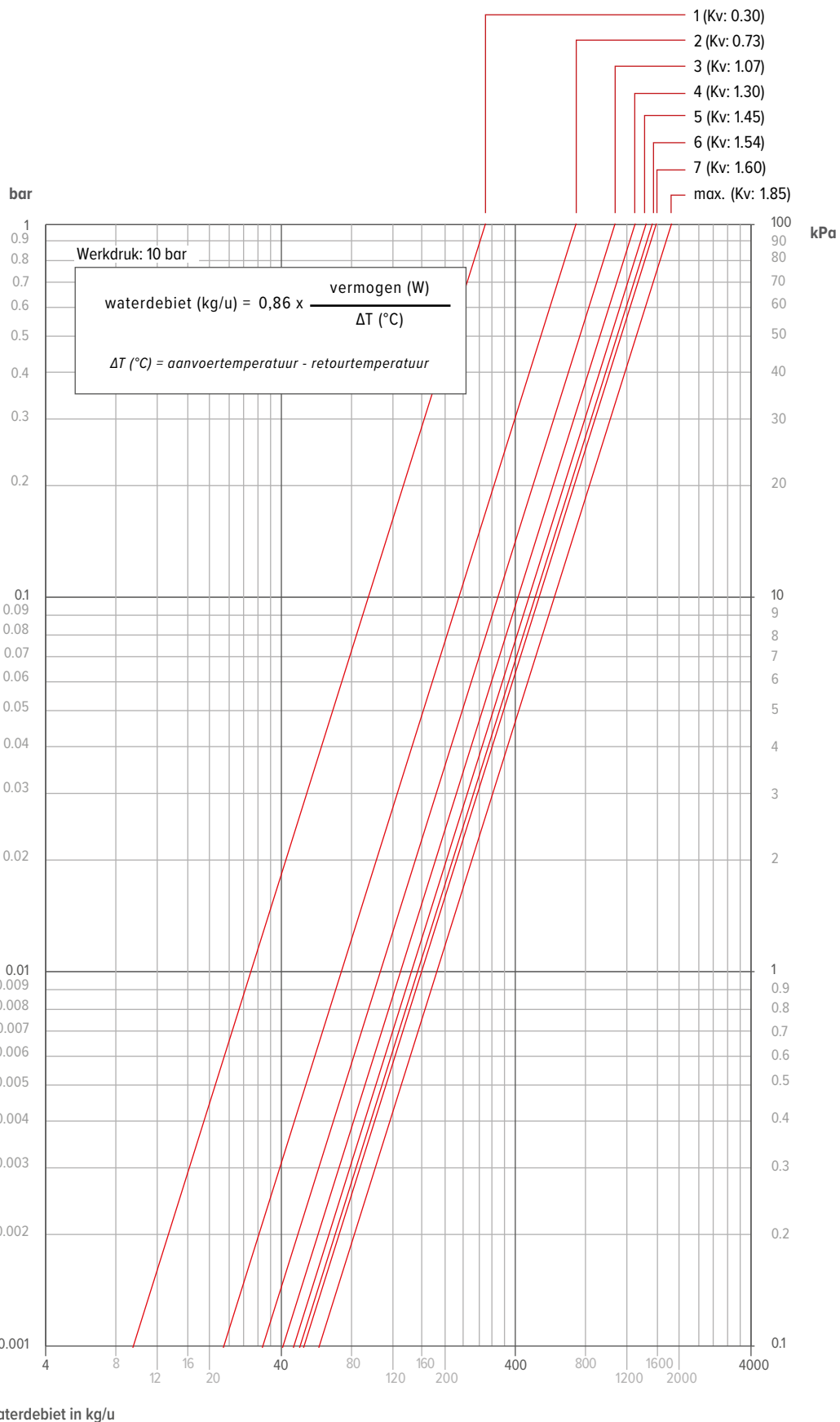

DRUKVERLIEZEN

KLEINE KV

VOORINSTELLING	0	1	2	3	4	5	6
RADIATORVOEDING %	0	100	100	100	100	100	100
KV	0	0.10	0.19	0.30	0.36	0.50	0.84

JAGA DECO THERMOSTAATVENTIEL HAAKS

5094.5422 chroom



JAGA DECO THERMOSTAATVENTIEL RECHT

5094.5420 chroom

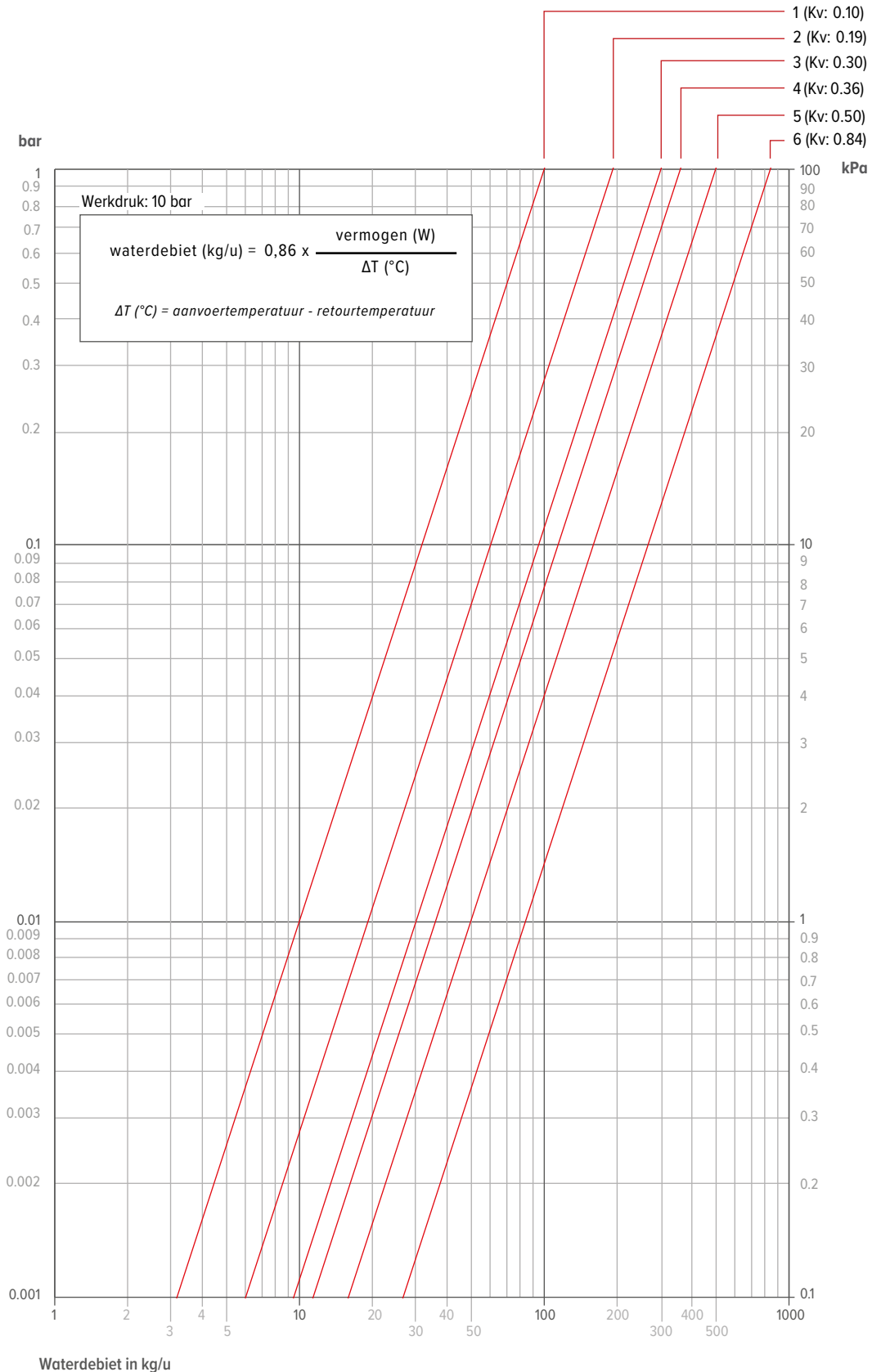

DRUKVERLIEZEN

AANTAL OMWENTELINGEN	dicht	0.5	1.0	1.5	open
RADIATORVOEDING %	0	100	100	100	100
KV	0	0.44	1.04	1.28	1.31

JAGA DECO RETOURVENTIEL HAAKS

5096.004 chroom



JAGA DECO RETOURVENTIEL DUBBEL HAAKS

5096.005 chroom



JAGA DECO RETOURVENTIEL RECHT

5096.003 chroom

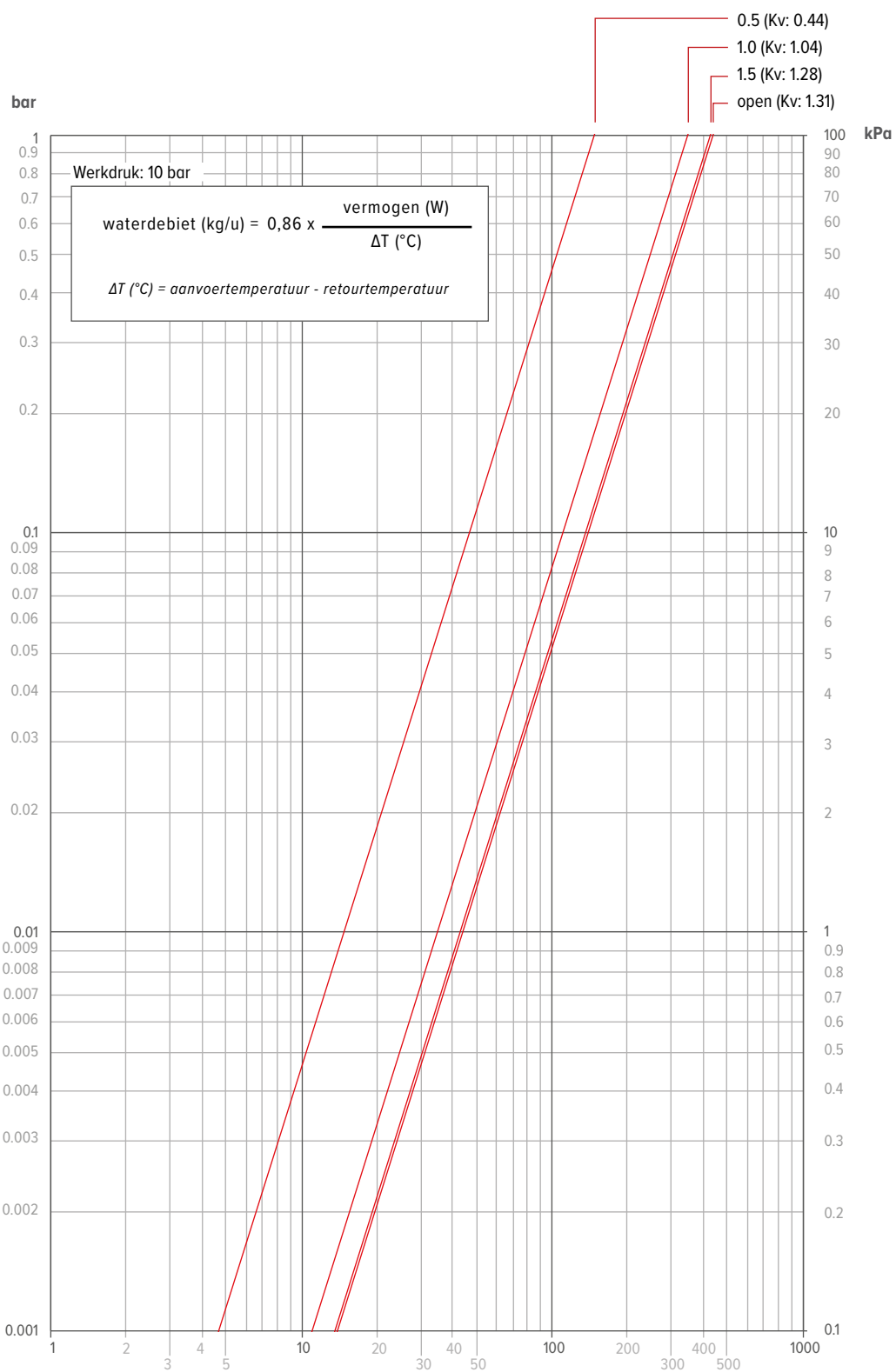

DRUKVERLIEZEN

ÉÉNPIJP

VOORINSTELLING	0	1	2	3	4	5	6	7
RADIATORVOEDING %	0	19	34	40	43.5	45.5	47	47.5
KV	1.10	1.36	1.66	1.84	1.95	2.02	2.07	2.10

JAGA DECO HAAKS EENPUNTSVENTIEL

5094.428 chroom



JAGA DECO RECHT EENPUNTSVENTIEL

5094.426 chroom

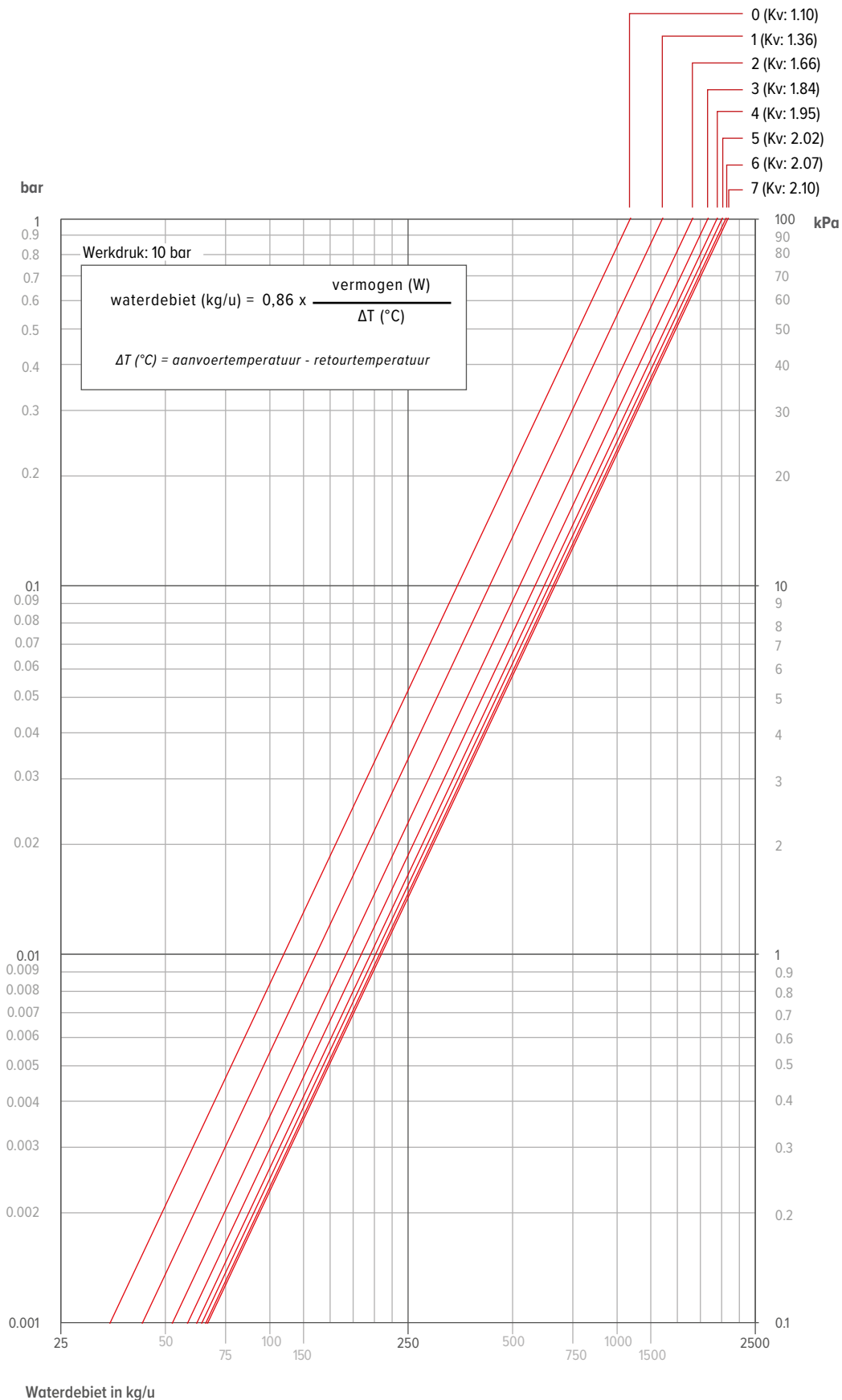

DRUKVERLIEZEN

TWEEPIJP

VOORINSTELLING	0	1	2	3	4	5	6	7
RADIATORVOEDING %	0	100	100	100	100	100	100	100
KV	0	0.28	0.61	0.83	0.97	1.06	1.11	1.15

JAGA DECO HAAKS EENPUNTSVENTIEL

5094.428 chroom



JAGA DECO RECHT EENPUNTSVENTIEL

5094.426 chroom

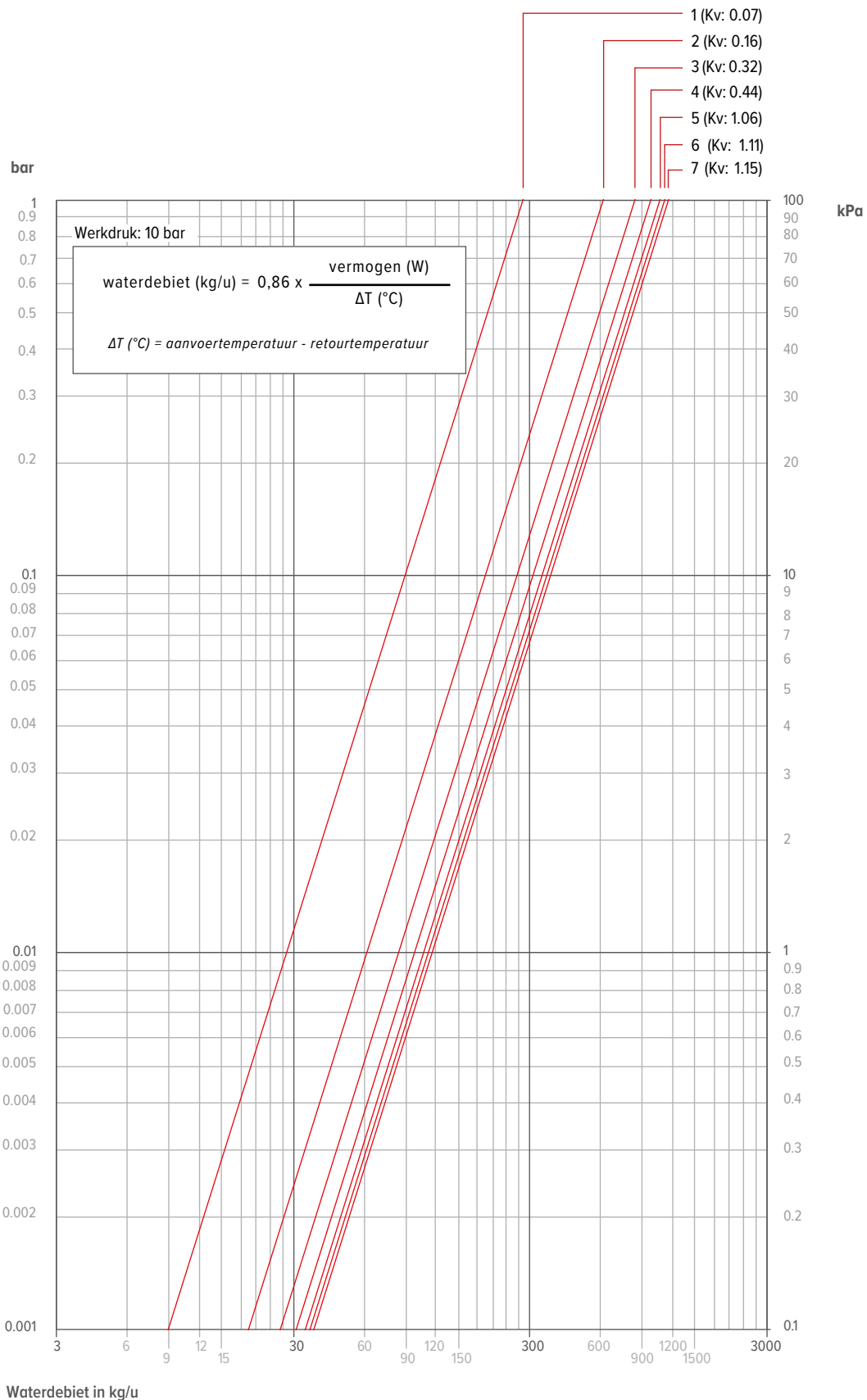

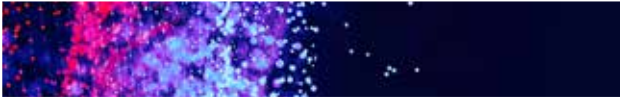

jaga CLIMATE
DESIGNERS

NEDERLAND KONVEKTCO NEDERLAND BV

Persoonlijk advies? Maak een afspraak in het Jaga adviescentrum in 's-Hertogenbosch!

+31 (0)73 631 23 60

info@jaga.nl
www.jaga.nl

BELGIË JAGA NV

Verbindingslaan 16
3590 Diepenbeek

+32 (0) 11 29 41 11

info@jaga.be
jaga.com